

Square Deal “B” Reloading System Assembly and User Instructions

Dillon Precision, Inc.



Copyright © 2020 by Dillon Precision, Inc.--All rights reserved. This publication is for personal use only. No part of this publication may be reproduced, distributed, or transmitted in any form or by any means, including photocopying, recording, or other electronic or mechanical methods, for commercial use without the prior written permission of Dillon Precision.

Square Deal™ and Dillon Square Deal B Reloading System™ are trademarks of Dillon Precision Inc.

TABLE OF CONTENTS

- 1. THE BASIC RISK OF RELOADING---Page 4**
- 2. MANDATORY SQUARE DEAL “B” USER SAFETY MINIMUM REQUIREMENTS—Page 4**
- 3. SQUARE DEAL LIMITED LIFETIME WARRANTY—Page 5**
- 4. SQUARE DEAL SHIPPING CONTENTS—Page 5-6**
- 5. SQUARE DEAL ASSEMBLY GUIDE—Pages 6-11**
- 6. OPTIONAL EQUIPMENT FOR THE SQUARE DEAL—Page 12**
- 7. THE DILLON SQUARE DEAL RELOADING STATIONS AND CONFIGURATIONS—Pages 13-15**
- 8. SETUP PROCEDURES FOR THE SQUARE DEAL—Pages 16-30**
 - 8.1. Description of Square Deal Die Assemblies**
 - 8.2. Square Deal Friction Plate**
 - 8.3. Station 1--Sizing and Depriming**
 - 8.4. Station 2a--Primer Feeding and Seating**
 - 8.5. Station 2b—Powder Measure Setup and Case Mouth Belling**
 - 8.6. Station 3--Bullet Seating**
 - 8.7. Station 4--Bullet Crimping**
- 9. CONVERSION LIST AND REPLACEMENT PROCEDURES—Pages 30-39**
 - 9.1. Caliber Conversion List**
 - 9.2. Shellplate Caliber and Primer Size Conversion**
 - 9.3. Die Caliber Conversion**
 - 9.4. Powder Measure Bar Conversion**
 - 9.5. Depriming Pin Replacement**
 - 9.6. Primer Early Warning Battery Replacement**
- 10. ADJUSTMENT AND REPLACEMENT PROCEDURES—Pages 40-43**
 - 10.1. Shellplate Indexing Adjustment**
 - 10.2. Adjusting Primer Feeding/Alignment**
- 11. TROUBLESHOOTING THE SQUARE-DEAL—Pages 44-46**
- 12. CLEANING AND LUBRICATING THE SQUARE DEAL—Pages 47-49**
- 13. SUB-ASSEMBLIES AND PARTS IDENTIFIER—Pages 50-56**
 - 13.1. Main Assembly**
 - 13.2. Frame and Lower Assembly**
 - 13.3. Automatic Primer Assembly**
 - 13.4. Primer Early Warning Assembly**
 - 13.5. Primer Slide Assemblies**
 - 13.6. Primer Early Warning System**
 - 13.7. Automatic Powder System**
- 14. RELOADING BASICS--Pages 57-59**
- 15. NOTES--Page 60**

DILLON PRECISION DISCLAIMER, EXPLANATION OF SAFETY WARNINGS, DILLON CONTACT INFORMATION

DISCLAIMER

The material in this manual is for informational purposes only. The products it describes are subject to change without prior notice. Dillon Precision Inc. makes no representations or warranties with respect to this manual. Dillon Precision Inc. shall not be liable for any damages, losses, costs or expenses, direct, indirect or incidental, consequential or special, arising out of, or related to the use of or the inability to use the products described herein. Read this manual before using this product. Failure to follow the instructions and safety precautions in this manual can result in serious injury or death. Keep this manual in a safe location for future reference.

EXPLANATION OF SAFETY WARNINGS

DANGER!

Danger! indicates a hazard with a high level of risk that if not avoided, will result in death or serious injury.

WARNING!

Warning! indicates a hazard with a medium level of risk that if not avoided, could result in death or serious injury.

CAUTION!

Caution! indicates a hazard with a low level of risk that if not avoided, could result in minor or moderate injury.

Dillon Contact Information

Dillon Precision Inc.
8009 E. Dillon's Way
Scottsdale, AZ 85260
480-948-8009 1-800-223-4570
FAX 480-998-2786
Website: www.dillonprecision.com
E-mail: dillon@dillonprecision.com

Sales, Technical Support and Customer Service
800-223-4570

Document Revisions

Date	Version Number	Document Changes
1-1-2021	0	Initial Release Updated Manual

MANDATORY SAFETY PRECAUTIONS—MUST BE READ

1. The Basic Risk of Reloading, and Overall Square Deal Design Usage Safety:

1. **DANGER!** *The reloading of ammunition and the handling of reloading components used in the reloading process is inherently dangerous. Accidents and mistakes in loading can and do occur, sometimes with disastrous results resulting in, but not limited to loss of hearing, vision, limbs or life. These accidents can occur with the novice and experienced reloader.*
2. *Dillon Precision Inc. has designed the Square Deal “B” with user safety in mind, doing everything Dillon Precision Inc. knows to make the use of the Square Deal “B” as safe as possible.*

2. Mandatory Square Deal User Safety Minimum Requirements:

1. *Dillon Precision Inc. cannot guarantee the complete safety of the reloader/user of the Square Deal “B”. To minimize the user’s risk, use common sense when reloading and follow these basic safety rules at a minimum.*
2. **KNOWLEDGE:** *Study and learn the basics, processes and specifications used in the reloading of ammunition from reputable sources and publications by prominent bullet and powder manufacturers such as Sierra, Hornady, Speer, Western Powders and Alliant Powders; including reloading manuals such as the Lyman Reloading Manual and the Western Powder Reloading Guide.*
3. **EYE AND EAR PROTECTION:** *Never operate the Square Deal without eye and ear protection.*
4. **PAY ATTENTION:** *Give your full attention to the reloading process. Do not watch television, the internet or converse with anyone while loading. It is a full-time operation.*
5. **INTERRUPTIONS:** *If you are interrupted in any manner, always inspect the cases at every station and know exactly what has been done to ensure that proper process steps have or have not been completed.*
6. **SMOKING/IMPAIRMENT:** *Do not smoke or allow anyone to smoke in the reloading area. Do not allow open flames. Do not load if you have been drinking alcohol or are impaired in any way.*
7. **SAFETY:** *Do not remove any safety device(s) from the reloader or modify the reloader in any way. Keep components and ammunition out of the reach of children.*
8. **LEAD--CAUTION!** *Almost all bullets have a lead component, which may or may not be exposed. Be sure to have proper ventilation while handling the lead component (bullet) or when shooting. Lead causes birth defects, reproductive harm and cancer. Wash your hands thoroughly after handling lead components or shooting.*
9. **POWDERS--DANGER!** *There are many kinds of powders (propellants) used in the reloading process and are in general specified as rifle, pistol or shotgun powders. Powder selection is specific to the bullet caliber, weight and type of bullet being reloaded. There is no way to overstate the care and selection of a powder to be used in the reloading process. Again, refer to established bullet and powder manufacturers. Using the wrong powder or amount of powder or mixing powders can result in serious injury or death. Never mix powders. Always store the powder in its original container. Never have more than one type of powder in the reloading area at one time—preferably store powders in a separate room. Observe all maximum load warnings.*
10. **PRIMERS—DANGER!** *Primers contain a small amount of a shock-sensitive chemical that explodes when struck by a firing pin or hammer or accidentally crushed. Never force primers. If they get stuck in the operation of the loader, carefully disassemble the reloader and gently remove the obstruction. Never attempt to clear primers that are stuck in either the primer pickup tube or the primer magazine tube. Never, under any circumstance, insert any type of rod into these tubes to attempt to push out stuck primers—PRIMERS CAN “CHAIN DETONATE.” If a primer(s) gets stuck in the magazine or pickup tubes flood the tube with penetrating oil/WD-40, throw it away and call Dillon for a free replacement. Never attempt to deprime a cartridge case with a live primer. Depriming a live primer is one of the most dangerous things you can do in reloading and can cause serious injury or death. Never attempt to further seat primers on a loaded cartridge. Use only the primer for the specific application for which you are loading.*
11. **BLACK POWDER--DANGER!** *Do not use black powder or black powder substitutes in any Dillon Powder Measure. Doing so can result in severe injury or death.*
12. **LOAD AND LOADED LENGTH—WARNING!** *Use only recommended load specifications from manuals and information supplied by established, known component manufacturers. Avoid maximum loads listed in loading manuals. Be extremely careful to avoid a double charge. Dillon has no control over the components and specifications used when reloading with the Dillon equipment. No responsibility is implied or assumed for results obtained through the use of or inability to use any such components or reloading specifications.*
13. **QUALITY CHECKS--***At a minimum, perform periodic quality checks every 50-100 reloads-ESPECIALLY the powder charge.*
14. **PROPERLY LABEL RELOADED AMMUNITION:** *Label the reloaded cartridge with the overall length, bullet manufacturer, type and weight-- primer manufacturer and type--powder manufacturer, type and powder charge and date loaded.*
15. **RELOADING AREA--** *The reloading area should be well lit, dry and comfortable without breezes.*
16. **BE PATIENT and OBSERVANT—** *Users should have no trouble achieving published loading rates that are conservative. Be smooth and steady. The reloading process is not a process to hurry-- If something does not LOOK RIGHT, SOUND RIGHT, OR FEEL RIGHT —STOP, LOOK and THINK! If the problem is not obvious—CALL Dillon Technical Support (800) 223-4570 or visit the troubleshooting section at www.dillonprecision.com.*

3. SQUARE DEAL "B" LIMITED LIFETIME WARRANTY

Dillon Precision Inc. warrants the Square Deal "B" for the life of the system against defects in material and workmanship. Dillon Precision Inc. will either repair or replace any part(s) that prove defective. Dillon Precision Inc. will provide repaired or replacement parts at Dillon's choice on an exchange basis. This limited warranty does not cover any damage to the product that results from improper installation, accident, abuse, misuse, natural disaster, abnormal mechanical or environmental conditions, or any unauthorized disassembly, repair or modification. This limited warranty shall not apply if: (i) the product was not used in accordance with any accompanying instructions, (ii) the product was not used for its intended function or (iii) the addition of any non-authorized equipment.

4. SQUARE DEAL "B" SHIPPING CONTENTS

4.1. Remove the following items from the top protective foam layer of the Square Deal "B" shipping box:

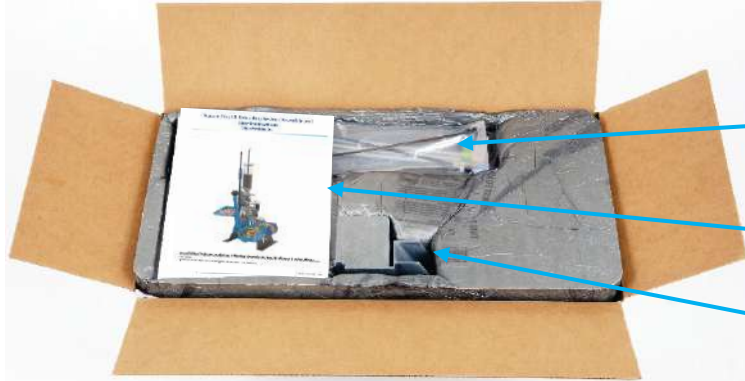

- Primer Early Warning System, Follower Rod, Battery and Tube Pack
- Square Deal "B" System Manual
- Square Deal Chute and Bin Bracket

4.2. Remove the following items from the second layer of protective foam



- Square Deal "B" Conversion Box
- Dillon Powder Measure
- Square Deal Press
- Bin and Accessory Bag



4.3. Contents of Square Deal "B" Shipment

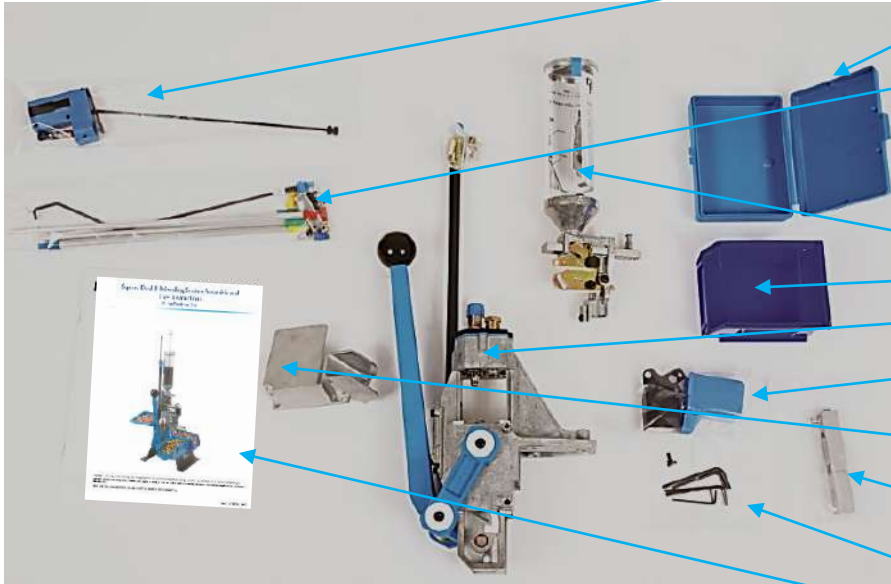

1. Primer Early Warning System and Primer Follower Rod
2. Caliber Conversion Box—Parts installed
3. Tube Pack accessory parts bag—Primer Pickup and Magazine Tubes, and Spare Tips—Large Tube Pack PN22016 Small Tube Pack PN22017
4. Powder Measure
5. Completed Cartridge Bin
6. Square Deal "B" with Caliber Specific Dies Installed
7. Used primer cup and Powder Measure Return Bracket
8. Ejected Cartridge Chute and Completed Cartridge Bin Bracket
9. Large Powder Bar (Small Bar installed in Powder Measure)
10. Included Allen Wrenches
11. Square Deal "B" Instruction Manual

5. SQUARE DEAL "B" ASSEMBLY GUIDE

- 5.1 To mount the Square Deal "B", select a clear area on your reloading bench. Your bench must be strong enough to support the weight and the force required to operate the Square Deal "B". If possible, attach your bench to the wall. Remove the Square Deal "B" Reloader from the packaging and place it on your selected area. You will need 7/16" wrenches, a drill motor and a 9/32" drill bit and the included Allen wrenches.
- 5.2 Locate the provided Ejected Cartridge Chute/Bracket and two 1/4-20 x 3/8" Socket Head Mounting Screws and fasten the Bracket to the side of the Square Deal "B" as shown:

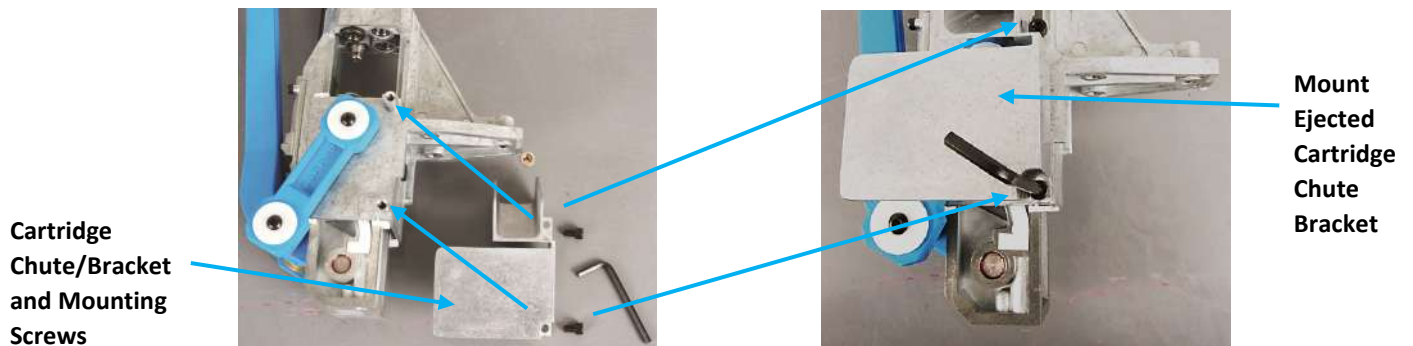

Cartridge Chute/Bracket and Mounting Screws

Mount Ejected Cartridge Chute Bracket

- 5.3 Locate the provided Spent Primer Bracket and two 8-32 x 3/8" Button Head Mounting Screws and mount Spent Primer Cup Bracket securely to the bottom of the Square Deal "B" as shown below:

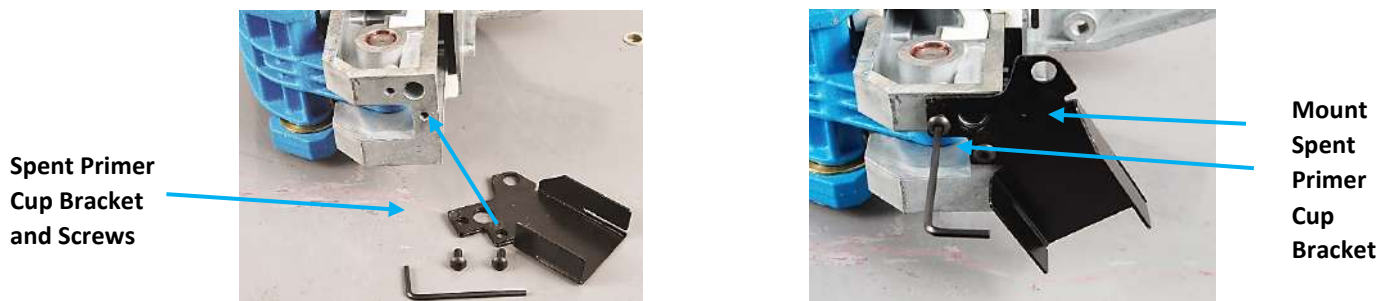

Spent Primer Cup Bracket and Screws

Mount Spent Primer Cup Bracket

5.4 The Square Deal "B" can be mounted directly to your bench (If you are using the Dillon Strong Mount proceed to 5.4.4 below). The preferred method of operating the Square Deal "B" is standing up. This gives you the leverage for the force needed to properly seat primers.

5.4.1 For mounting directly to a bench, bring the Square Deal "B" to the forward edge of your bench as shown below. The Square Deal "B" requires $\frac{3}{4}$ " clearance under the front edge of the bench. See below.

5.4.2 Mark the three mounting holes using the Square Deal "B" as a template. Remove the machine and drill three $\frac{9}{32}$ " holes through the bench. Bolt the Square Deal "B" securely to the bench with $\frac{1}{4}$ " Grade 5 hardware or available Dillon Mounting Hardware Kit P/N14355. Use small diameter washers on the top and large diameter washers on the bottom, especially if using a wooden bench.

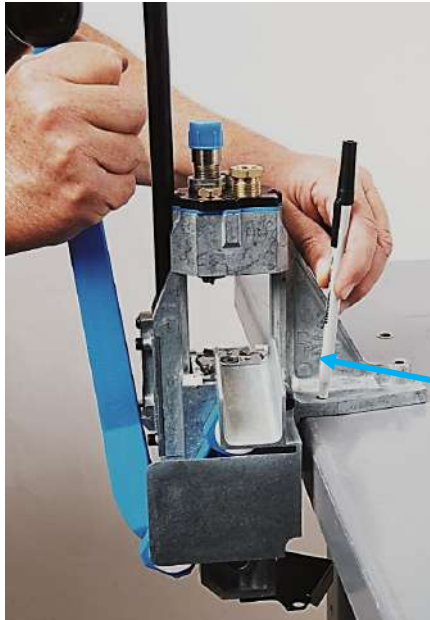

Mount Square Deal "B" with Base Mounting Flange tight against the bench making sure there is clearance below for the Crank, Operating Handle and the Spent Primer Cup

5.4.3 Slide the Spent Primer Cup into the mounting slots on the Bracket.

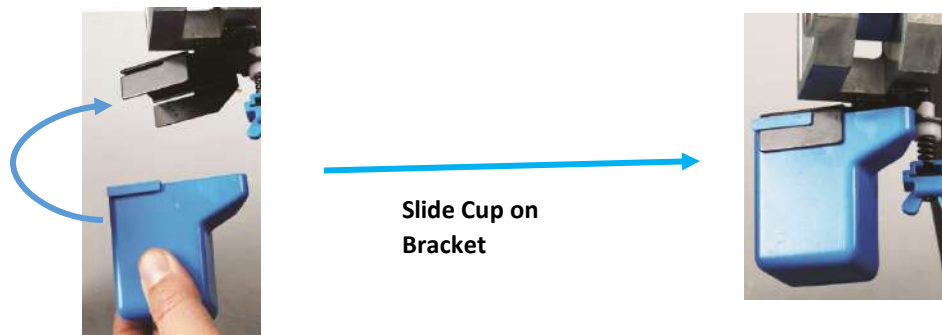

Slide Cup on Bracket

5.4.4 There are three other optional methods for mounting the Square Deal "B" to your bench.

- The first option is to use the available Billet Dillon Mounting Plate PN62005 by fastening the Plate to your bench and then mounting the Square Deal "B" to the Plate and as shown below:

Dillon Billet Mounting Plate fastened to your bench

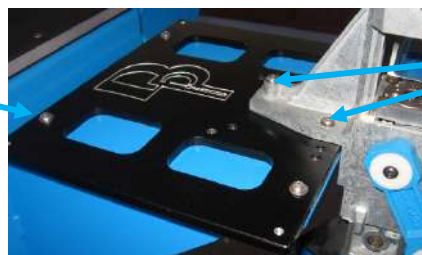

Square Deal "B" mounted directly to Dillon Mounting Plate with two $\frac{1}{4}$ "-20 x $\frac{3}{4}$ " Screws and one $\frac{1}{4}$ "-20 1 $\frac{1}{4}$ " Screw

- The second method is to install the Square Deal “B” on the Dillon optional Strong Mount using The Dillon Strong Mount Kit PN62395 and then mount the Strong Mount to the bench. Installation instructions are included with the Strong Mount. The Dillon Strong Mount improves the stability of the system by distributing the loading forces over a larger area of the bench and provides mounting locations for an optional Empty Case Bin and the provided Completed Cartridge Bin.



- The Third method is to fasten the Strong Mount with the Square Deal “B” to the optional Dillon Billet Mounting Plate PN62006 and then fasten the Billet Mounting Plate to the Bench as shown below.

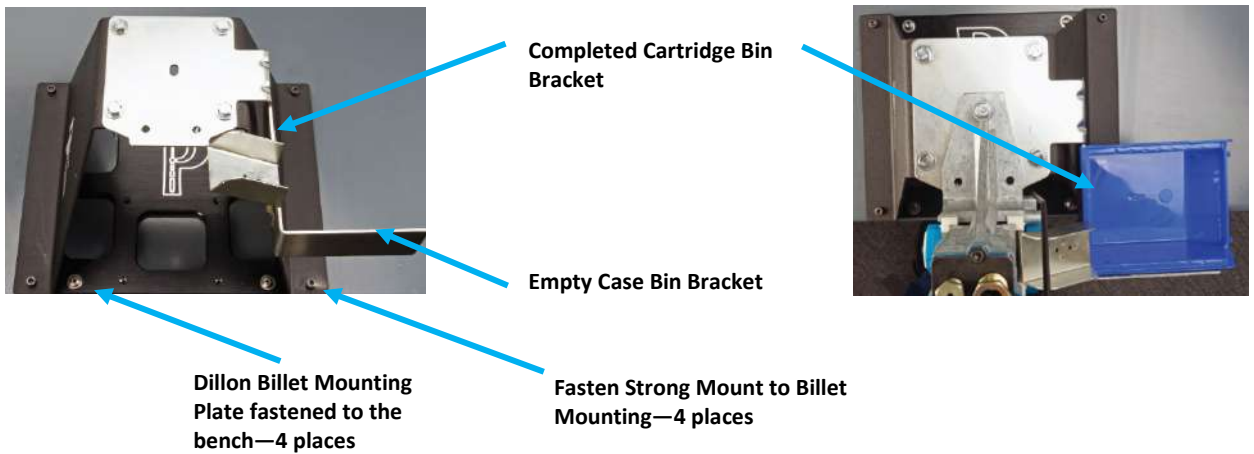

5.4.5 Install the completed Cartridge Bin on the Chute/Bin Bracket of the Strong Mount by sliding the lip on the bin over the bracket and the lip of the Empty Case Bin over the other bracket as shown below.

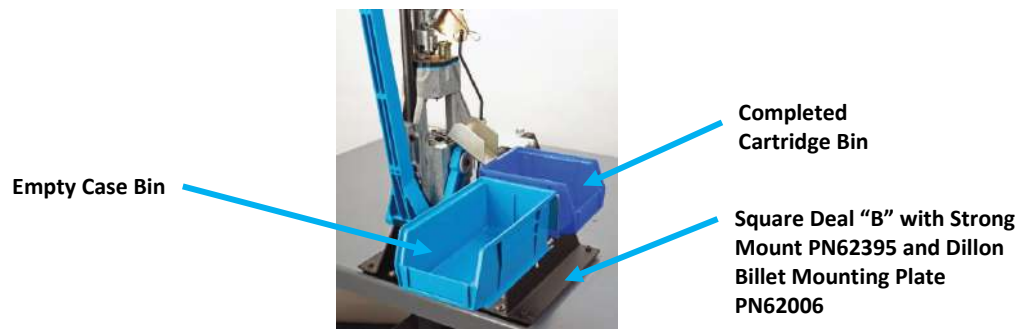

5.4.6 Install the optional Dillon Bullet Tray PN22214 on the left side of Strong Mount in the two holes as shown below with the hardware provided with the Bullet Tray Kit.

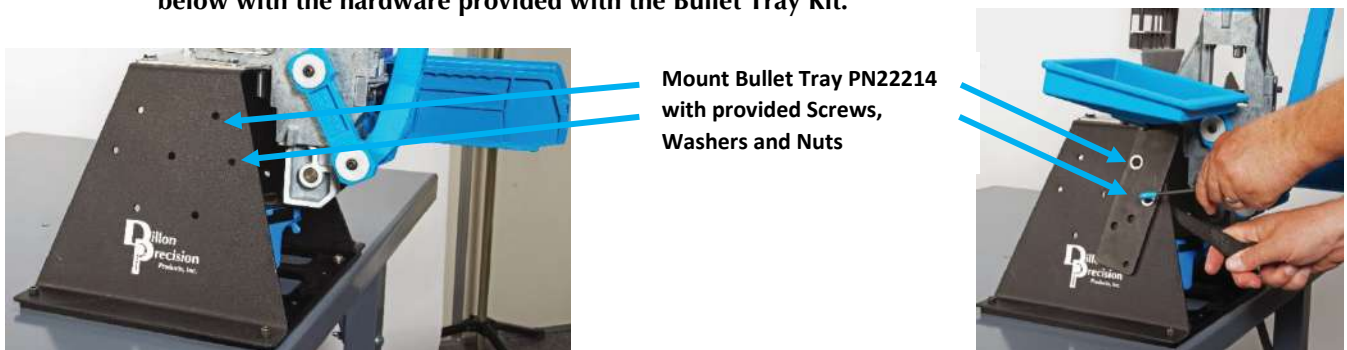

5.4.7 Install the optional Dillon Tool Holder with Wrench Set PN19441 as shown below. Remove the two 7/16" Hex Mounting Screws and nuts underneath for the Square Deal" B" and install the Tool Holder using the same two screws and nuts and tighten securely. Insert the Allen wrenches and Bench Wrench in their appropriate labeled positions in the Tool Holder.

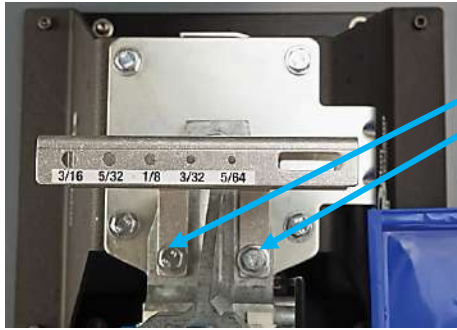

Mount Tool Holder with Wrench Set PN169441 using the two existing Square Deal Mounting Screws, Washers and Nuts

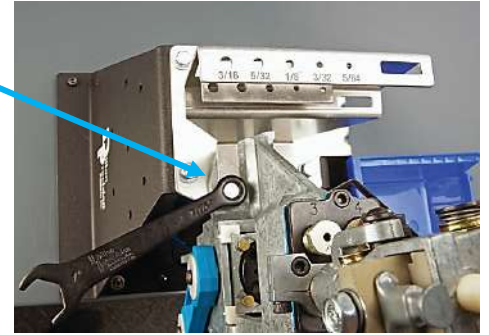

5.5 Install the Powder Measure

5.5.1 Remove the Blue shipping Cap from the Powder Die. Retrieve the Powder Measure from the shipment and remove the Powder Measure Clamp Screw and Clamp using the provided Allen wrench. Note--The Powder Funnel for the cartridge specified for the Square Deal purchased ships in the Powder Die.



Remove the Blue Cap from the Powder Die



The Powder Funnel is shipped/installed inside the Powder Die

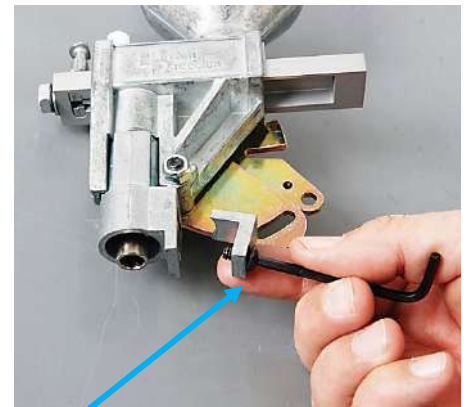

Remove the Powder Measure Screw and Clamp

5.5.2 Slide the Square Deal "B" Powder Measure down over the Powder Die and install the Clamp and lightly tighten the Clamp Screw. Further adjustment of the Powder Die is required later.

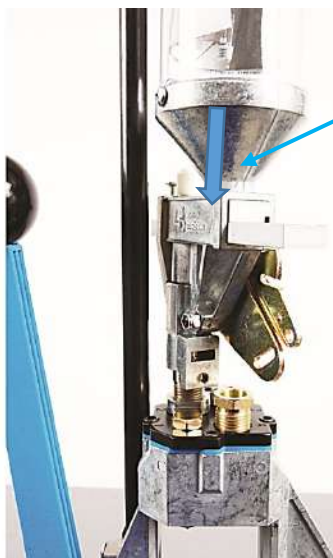

Place Powder Measure down over the top of the Powder Die



Install Powder Measure oriented as shown and lightly tighten the Clamp Screw with the provided Allen wrench

5.5.3 Locate the Failsafe Powder Measure Return Rod in the shipment and remove the top Spring Clip and the lower Blue Wing Nut, Spring and Bushing. Rotate the Powder Measure, aligning the Failsafe Rod vertically with the Failsafe Rod Bracket as shown below. Install the bottom threaded section of the Rod down through the hole in the Failsafe Bracket on the bottom of the Square Deal and slide the top hook through the hole and slot in the Lock-link Assembly of the Powder Measure. Reinstall the Spring Clip as shown below. Reinstall the White Bushing, Spring and Wing Nut on the Bottom of the Rod. Cycle the Operating Handle of the Square Deal "B" all the way down compressing the Failsafe Rod Spring. Adjust the Blue Wing Nut up leaving .030" of clearance (two credit card thicknesses) between coils when fully compressed. Re-adjustment may be necessary after setting the case mouth belling discussed later.

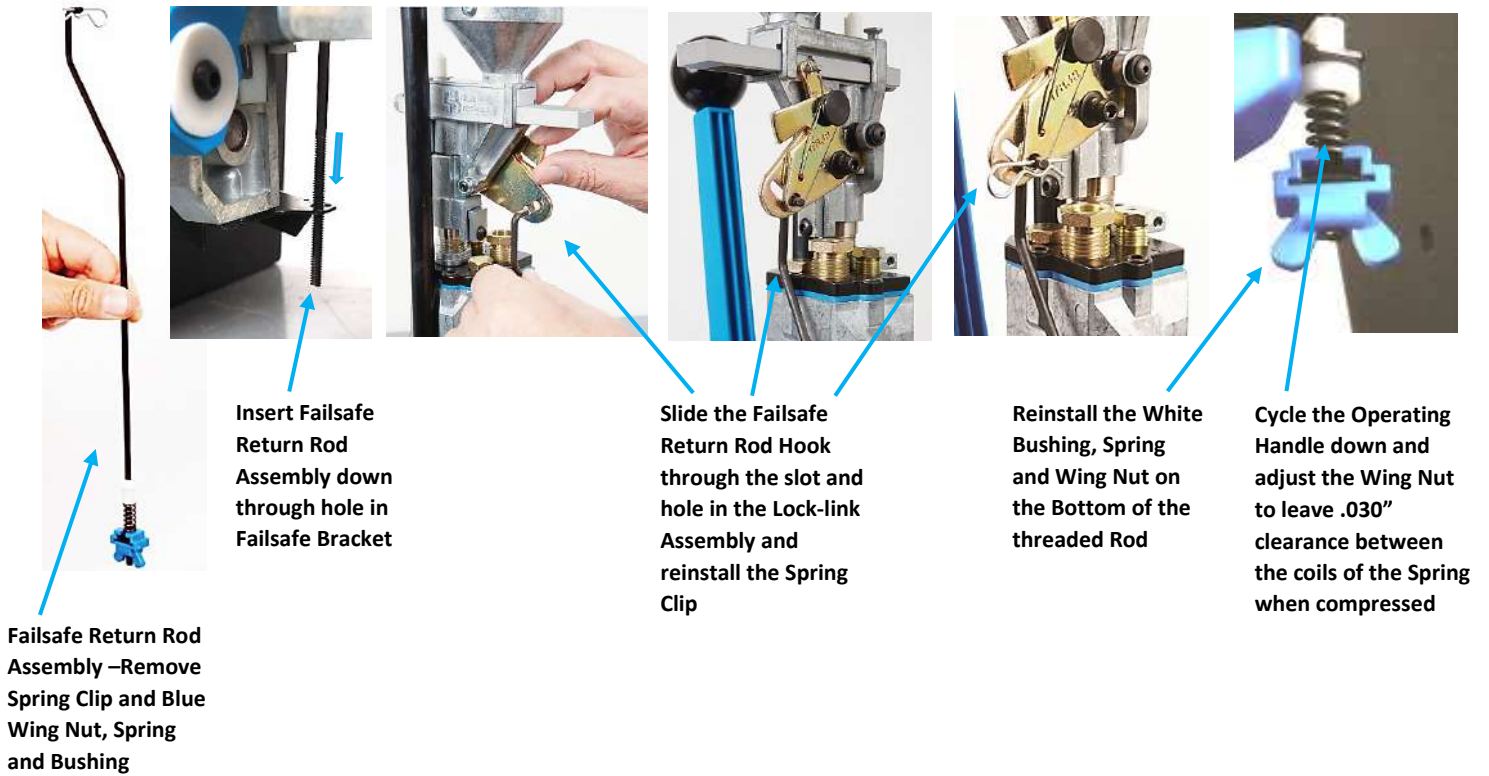

5.6 A plastic bag is secured to the top of the Primer Magazine Shield Tube and contains four (one spare) numbered Brass Locator Buttons for the caliber ordered, a spare Depriming Pin, an alternate Seating Stem (Two for .38/.357's), a sample case with a primer and a sample reloaded cartridge showing how the press was configured. Take three of the Brass Locator Buttons and install them in the Square Deal as shown below.

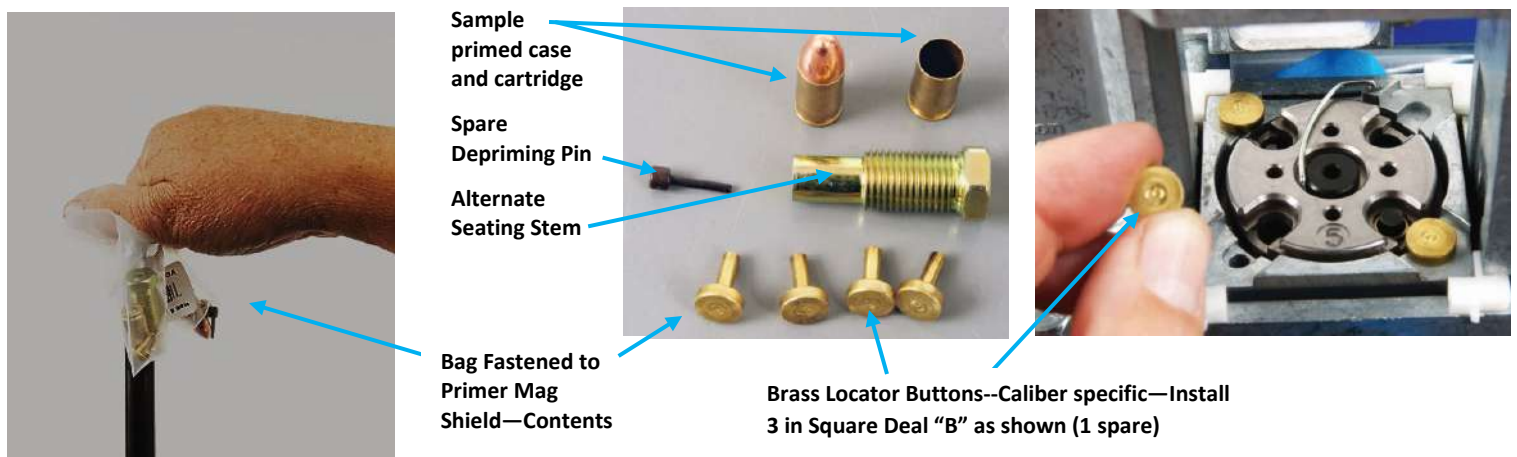

5.7 **Note:** The Square Deal ships with the Primer System size installed for the cartridge ordered. The alternate small or large Primer Assembly is shipped in the Accessory box. Refer to Section 8.3 on the Primer Conversion Procedures for changing primer size.

5.8 **Install the Primer Early Warning System**

- 5.8.1 The Primer Early Warning system emits a “beeping” sound when the Primer Magazine is down to the last three or four primers.
- 5.8.2 Simply push the Primer Early Warning System down over the Primer Magazine Shield Knurled Cap until it stops.
- 5.8.3 **WARNING! Do not put primers in the Magazine Tube until you have read this entire manual.**

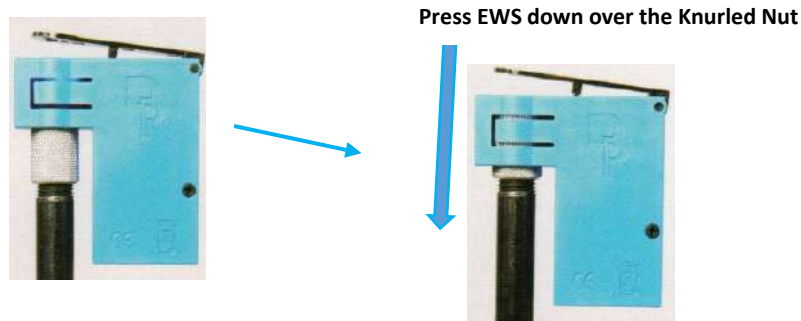

5.8.4 **Install the Primer Magazine Follower Rod as shown below. You can store the plastic Primer Follower Rod in the Magazine Tube when there are no primers in the Magazine Tube by putting it under the Operating Lever to stop the alarm from sounding when it is not being used.**

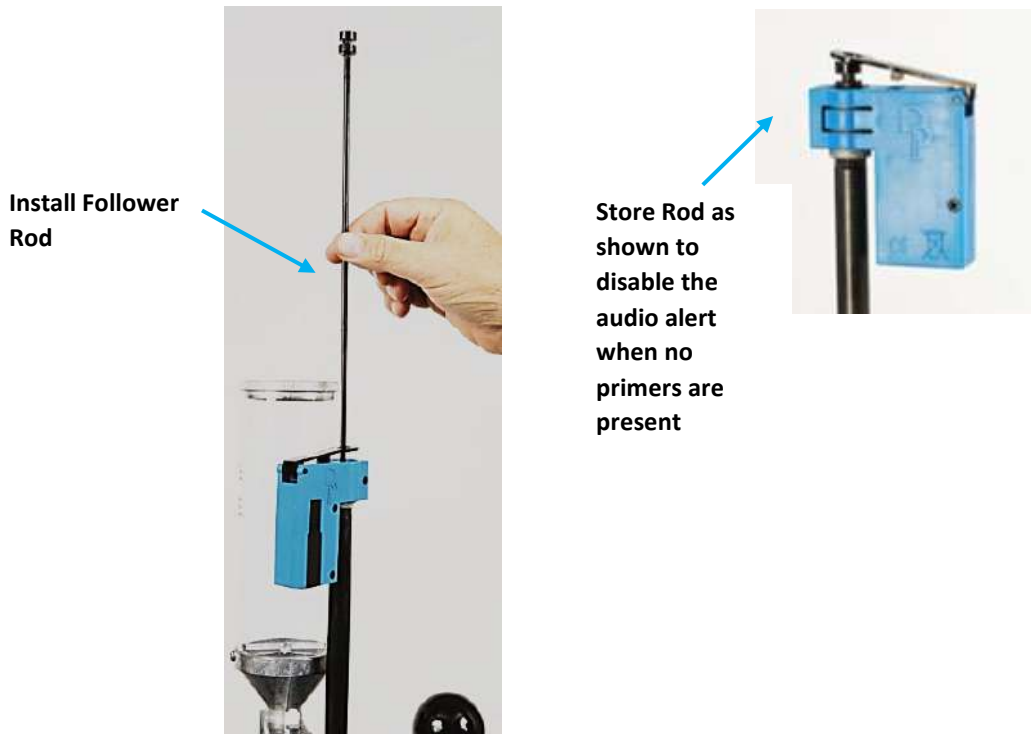

5.9 **Your assembly is complete. Cycle the Operating Handle making a full stroke down and up again and push fully to the rear to the priming position. The Shellplate should index clockwise. The Primer Slide should move back and forth and the Primer Punch will project up through the hole in the Shellplate.**

6. OPTIONAL EQUIPMENT FOR THE SQUARE DEAL "B":

- Square Deal Strong Mount and Case Bin: PN22051
- Tool Holder with Wrenches: PN19441
- Low Powder Warning Sensor: PN16306
- Square Deal "B" Toolhead Assy: PN20113
- Deluxe Quick Change & Stand: PN62265
- Spare Parts Kit: PN97015
- Bullet Tray: PN22214



**Note-- Conversion Kit
Shellplate and Dies sold
separately**

7. THE DILLON SQUARE DEAL "B" HAS FOUR RELOADING STATIONS AND USES UNIQUE DIES AND A POWDER MEASURE ASSEMBLY. The Toolhead and Shellplate are specific to the Square Deal "B" and are not compatible with any other dies or reloading system—see the description of the four stations and the operations below:

Station 3-
Seat Bullet

Station 4-Crimp Bullet
and Eject Cartridge

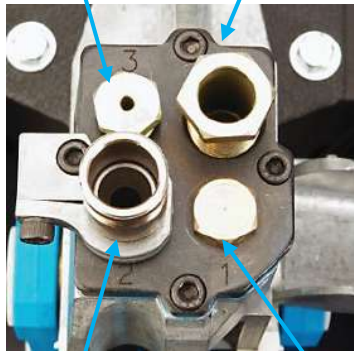

Station 2-Prime and
Dispense Powder

Station 1-Size
and Deprime

Square Deal Powder
Die and Clamp

Toolhead Assembly
with Blue Friction Plate

Square Deal Powder Measure
and Clamp Assembly

- STATION 1—DEPRIME AND SIZE CASE--(Number 1 engraved in the Toolhead)
- STATION 2--SEAT PRIMER, BELL CASE MOUTH AND DISPENSE POWDER (Number 2 in the Toolhead)
- STATION 3--SEAT BULLET--(Number 3 in the Toolhead)
- STATION 4--CRIMP BULLET AND EJECT COMPLETED CARTRIDGE--(Number 4 in the Toolhead)

Note--cases are automatically indexed from station to station every time the Operating Handle is cycled down and up.

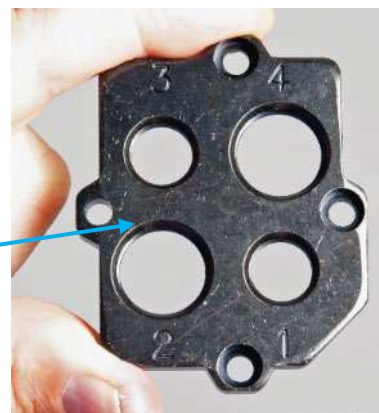
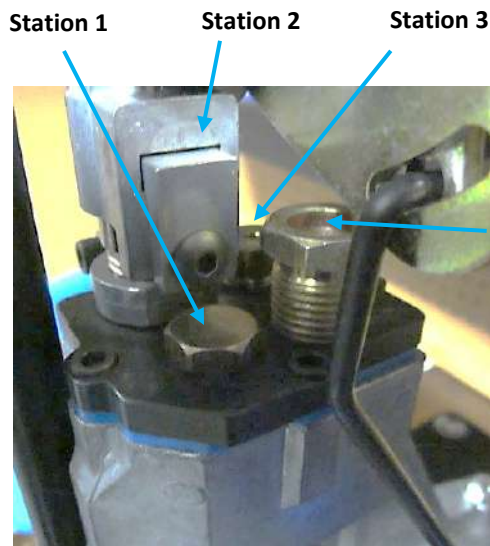
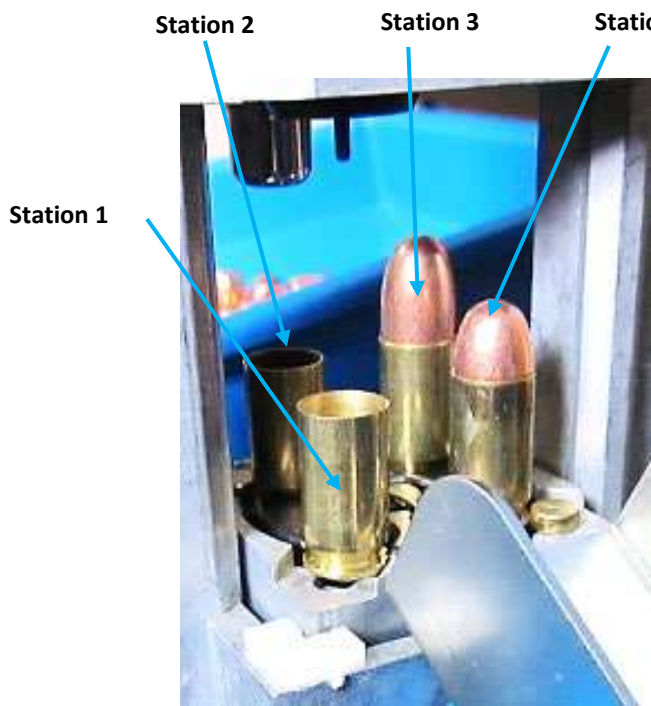

Each Station is numbered on the Toolhead 1 thru 4 as are the Size Die #1, the Seat Die #3 and the Crimp Die #4

7.1. Station 1— Case is Deprimed and Sized

- The user inserts a case into the Shellplate
- Cases are de-primed and sized on the downstroke of the Operating Handle
- On the upstroke, the case is indexed to Station 2 and a Primer is picked up by the Primer Slide and fed into Station 2



Station 1--Case manually inserted into Shellplate



Station 1--Case entering Depriming/Sizing Die as the Operating Handle is lowered raising the Shaft/Shellplate



Station 1—On the upstroke the case is indexed to station 2 and a primer is picked up and presented to Station 2

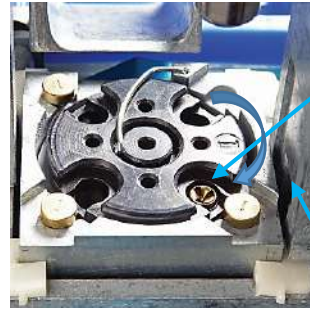

Case not shown in Station 2 for clarity

Station 1—Case Deprimed and Sized

7.2. Station 2—Primers Are Automatically Fed and Seated, The Case Is Flared (Belled) and the Powder Dispensed

- Primers are seated on the “full-push stroke” of the Operating Handle from the “at-rest” position of the Operating Handle
- On the downstroke, the case mouth is belled (flared) and powder dispensed into the case
- On the upstroke, the case is automatically indexed to Station 3



Station2--Primer seated push stroke of the Operating Handle from the at rest position



Neutral “at-rest” Position

Primer seating position



Station2--Case mouth flared and powder dispensed on the down stroke of the Operating Handle

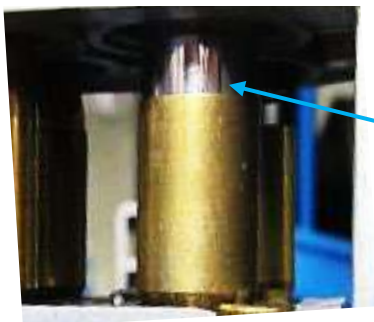

Station 2—Case being pushed over the nose of the Powder funnel bellling the case mouth and dropping powder into the case



Belling Feature of Powder Funnel

Station 2— Typical Dillon Powder Funnel— fits inside the Powder Die

Station 2—Primer Seated, Case Flared, Powder Dispensed

7.3. Station 3—Bullet Placed and Seated

- User places bullet on the case in Station 3
- On the downstroke, the bullet is seated
- On the upstroke, the case is automatically indexed to Station 4

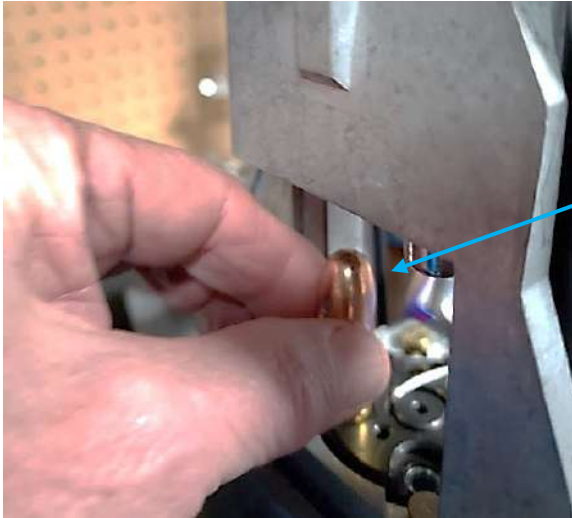

Station 3--Bullet Placed and Seated

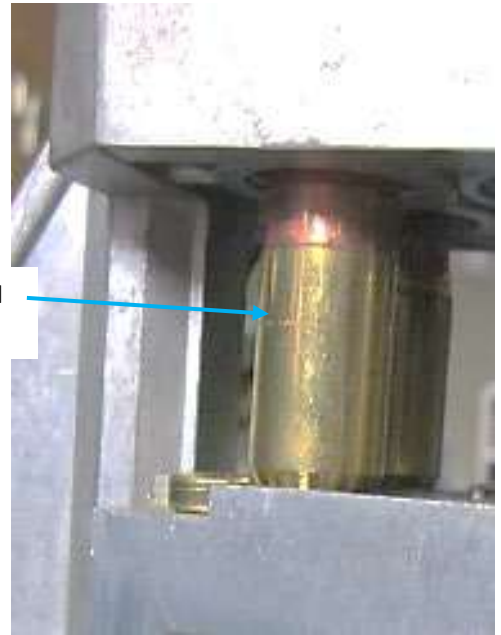

Station 3—Bullet Seating

7.4. Station 4—Bullet Crimped and Completed Cartridge Ejected.

- The Bullet is crimped on the downstroke
- The Cartridge is ejected on the upstroke



Station 4 (Crimp)



Station 4 (Eject)

Ejector Wire Ejects Cartridge into Cartridge Chute/Bin

8. **SETUP PROCEDURES FOR SQUARE DEAL "B"—WARNING!** Due to variations in components, check all stations for proper adjustments for the cartridge you are loading. You must read the following instructions. If there is something you do not understand, call (800) 223-4570 for technical assistance.

8.1. The Dies and Toolhead are unique to the Square Deal.

8.3.1 The Dies are numbered #1-Size Die, #3-Seat Die and #4-Crimp Die. They drop into the Square Deal Frame Station #1, #3 and #4 respectively as shown below.



Station #1--Size



Station #3--Seat



Station #4--Crimp

8.2. Another unique part of the Square Deal Toolhead Assembly is the Blue Friction Plate which is sandwiched between the Frame below and the Numbered Toolhead above. The Friction Plate keeps the threaded parts of the dies from easily turning. The remaining parts are assembled as described below:



Friction Plate



Numbered Toolhead



Square Deal "B" Toolhead Assembly

8.3. Station 1—Sizing and Depriming

8.3.1 There is no adjustment required for Station 1--The Size Die with its Carbide insert drops into Station 1 and is secured by the Toolhead. The Depriming Assembly threads flush into the Toolhead. The Deprime and Size Components are shown below. The case is sized and Deprimed in Station #1 on the downstroke of the Operating Handle. (Note—a Primer is picked up by the Primer Slide in Station #2 during the downstroke of the Operating Handle during the Sizing/Depriming Operation in Station #1).

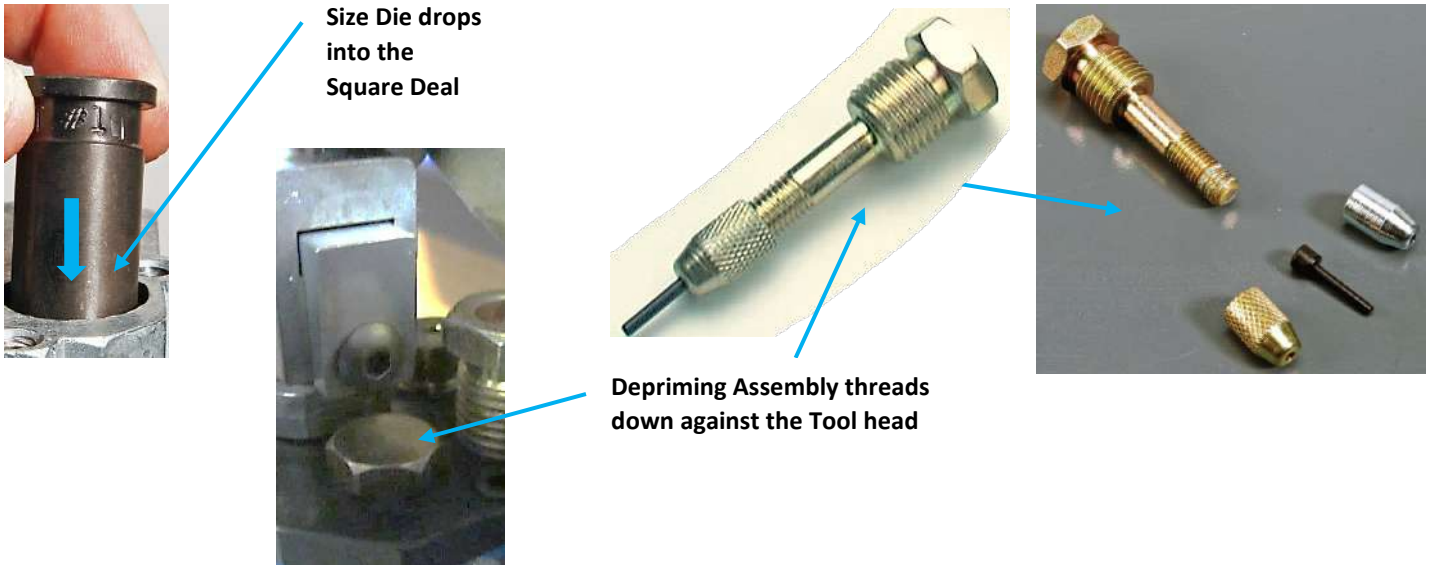

8.4 Station 2a--Primer Feeding, Seating, Case Belling and Powder Dispensing--The First Operation of Station 2 is (a) to seat a primer on the full push stroke of the Operating Handle. The Second Operation of Station 2 is to (b) expand the case mouth and dispense powder on the downstroke of the Operating Handle.

8.4.1 The Square Deal "B" incorporates an Automatic Linear Primer Feed System utilizing standard Large or Small Primer Magazine Tubes and interchangeable Large and Small Primer Slides. The Square Deal "B" comes with the primer size specific to the cartridge ordered. The alternate size Primer Slide is shipped separately. A Large Powder Bar for the Powder Measure is also included. These components are in the "Tube Pack" --see shipping contents.

8.4.2 A Primer Early Warning System (EWS)/Low Primer Alarm system is provided. The Primer Follower Rod is the Actuator for the Primer Early Warning System.

Primer Follower Rod and Assembly and Primer Early Warning System

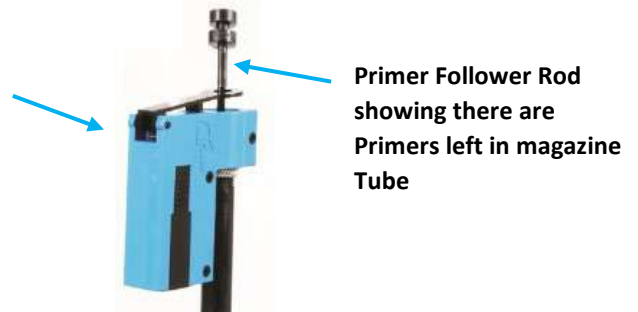

8.4.3 A primer is automatically picked up by the Primer Slide and Primer Cup Assembly from the Primer Magazine. It is then positioned under the hole in the Shellplate in Station 2 as the case is indexed from Station 1 during the upstroke of the Operating Handle. The Primer is then seated with a complete push stroke of the Operating Handle.

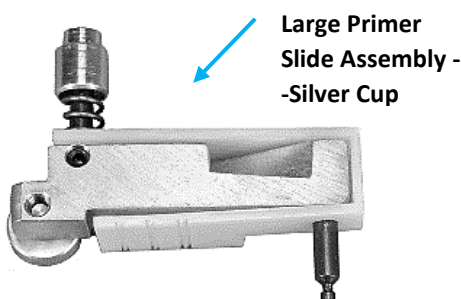

Primer pushed up by Primer Punch ready to be installed if a case was present

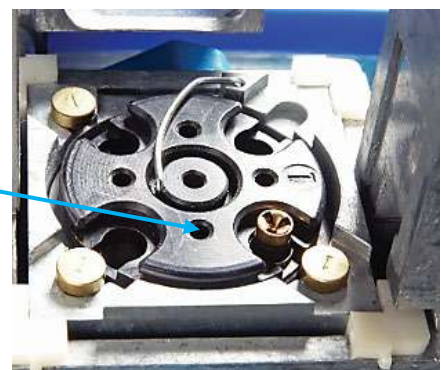

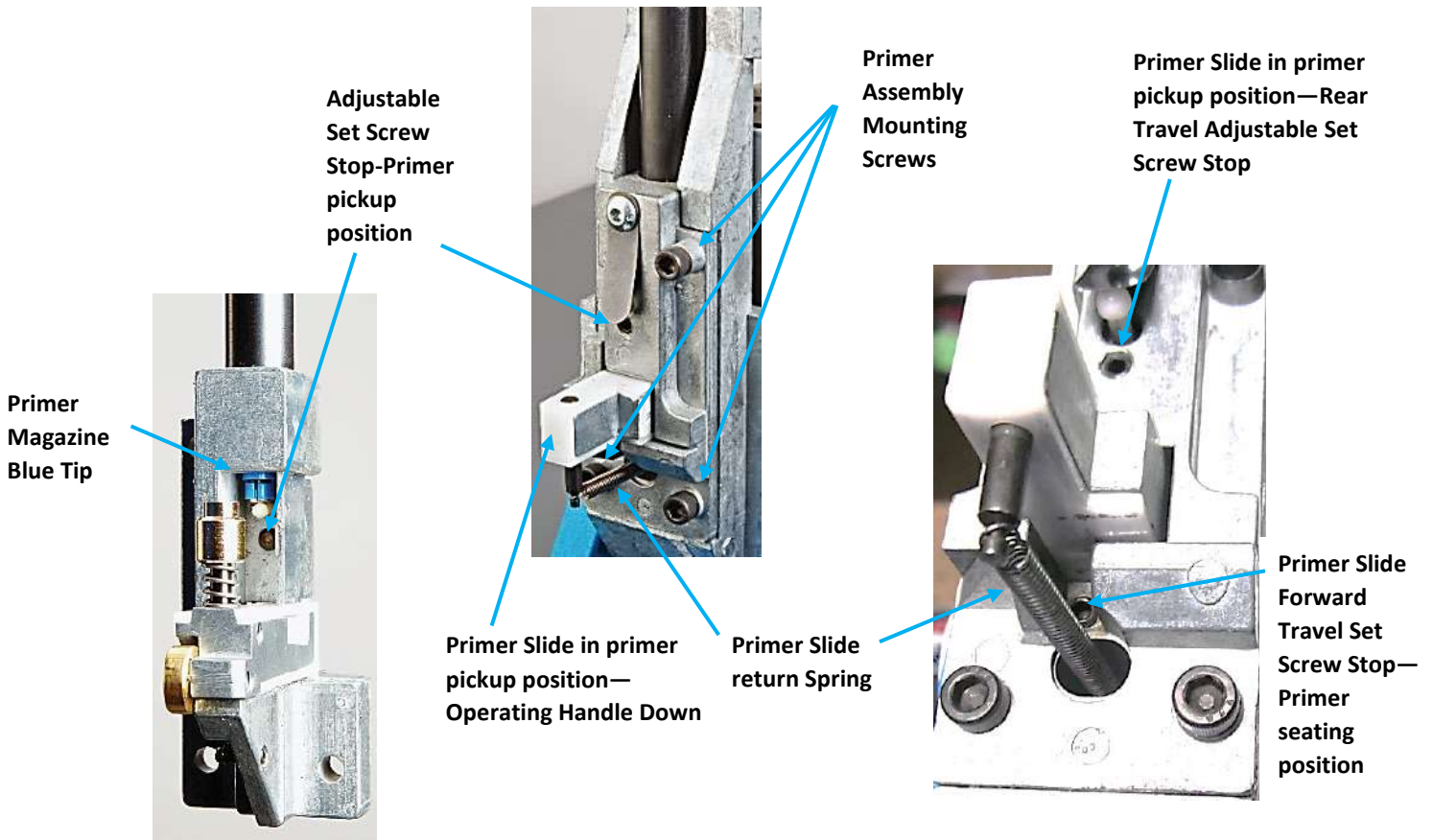

8.4.4 The Operation of The Automatic Primer System

- The Square Deal “B” comes set up in the primer size for the cartridge ordered. The alternate size Primer Slide Assembly ships separately.
- Primers are seated by pushing the Operating Handle fully to the rear, from the Operating Handle’s “at rest position” at the top of the Square Deal’s stroke.



Operating Handle “at-rest position”



Push Handle fully to the rear to seat a primer

- **CAUTION!**
 - *Learning to feel the correct force to seat a primer is a critical method in the reloading process.*
 - *The Prime will not be seated to the proper depth if the Handle is not pushed firmly and fully to the rear primer seating position.*

- *If the primer takes too much force to be seated and the Handle cannot be pushed fully to the rear—STOP and inspect the case. The primer pocket may be damaged or could have a crimped primer pocket or the Primer Cup may not be aligned properly with the Shellplate.*
- *Low resistance to seating a primer can indicate an enlarged primer pocket that may not retain the primer. Discard this case.*
- Verify that the system feeds primers as follows:
 - Remove the plastic Follower Rod and unscrew the Magazine Cap.
 - Remove and verify the Magazine Tube is of the correct size/color--The blue tip for small primers and the red tip for large primers. *Note: Any primers left in the Magazine Tube will fall out in the Magazine Shield Tube.*

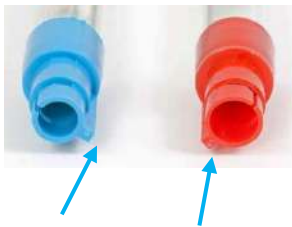

Magazine Tip Alignment Tab

- Install the Magazine Tube in the Magazine Shield. The tab on the plastic Magazine Tip, red or blue, must be gently aligned with the slot down in the Primer Feed Body Housing and then should slide down about a 1/4" more. Tighten the knurled Magazine Cap just snug.

Magazine Cap fits over end of Magazine Tube

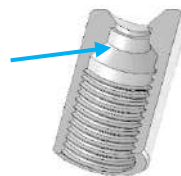

Tighten knurled Magazine Cap just snug



- With the Operating Handle up in its at-rest position, manually take one primer that you will be using and drop it anvil side up in the hole in the Magazine Cap as below:



- Cycle the handle smoothly down and back up to the top of the stroke to the "at rest position."
- The primer should present itself in the Priming Station on top of the Primer Punch as shown below—repeat this step 3 times--if successful proceed to the next step, if not, proceed to Primer Drop Alignment Section 10.2.



Correct presentation of primer—Single primer drop test—Primer ready to be seated Station 2

8.4.5 Verify Primer Seating Depth

- With a primer in the cup as above and the Operating Handle in its up at-rest position, put a de-primed case in Station 2. Push the Operating Handle fully to the rear seating the primer. Remove the case and verify the primer is seated flush or slightly below flush.
- The primer seating depth is an important parameter to control when reloading and can be a safety issue. The ideal seating depth is .002" to .006" (.008" Max) below the case head. **WARNING! "High" or protruding primers can lead to slam fires in semi-autos or firing out of battery and can stop the cylinder from rotating in revolvers.** Seating the primer too deep can cause damage to the primer, causing misfires and or inconsistent ignition. Refer to Section 14 on Primer Basics.

Primer on right is seated properly-- the one on the left is high



Primer Seated .002" to .006" Below Flush Recommended (.008" Max.)

Primer Anvil Initially Compressing Primer Compound

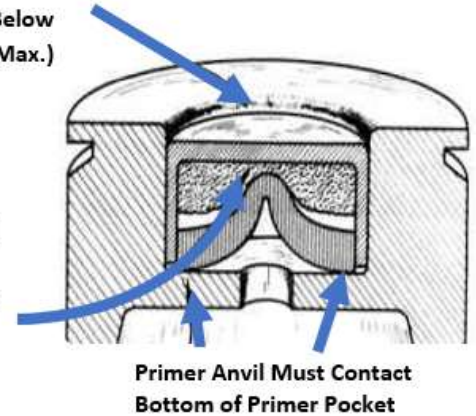

Primer Anvil Must Contact Bottom of Primer Pocket

Courtesy of Western Powders

8.4.6 Filling the Primer Magazine-- Dillon offers two choices for filling the primer magazine:

- Manually as below with an optional Dillon Primer Flip Tray and Dillon Primer Pickup Tubes. Pickup Tubes are included with the Square Deal "B".
- The Primer Pick-Up Tubes have different colored tips. They have been color-coded to identify size easily. The color code is as follows:

Primer Pickup Size	Pickup Tip Color	Dispense Tip Color
Small	Yellow	Blue
Large	Green	Clear

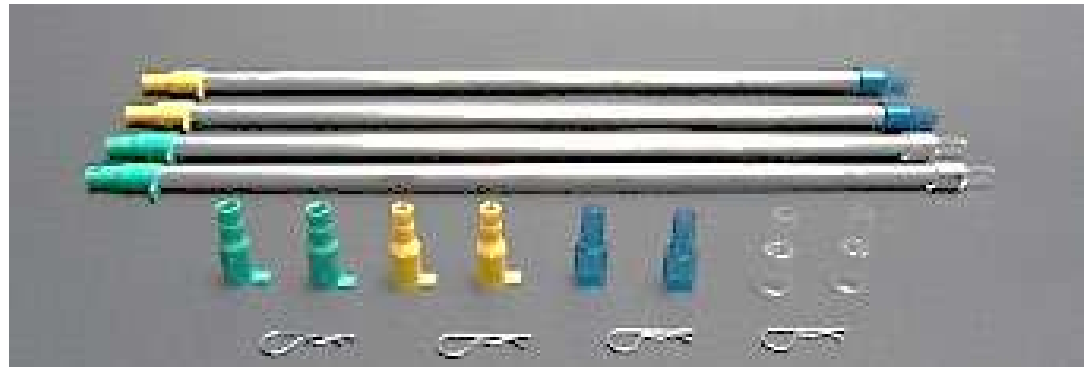

- **WARNING! Put on safety glasses!**

- Place primers on the half of the Flip Tray with the ribs. Oscillate the tray and primers around until all the primers are flat. Pick up all the primers that are shiny side up by placing the Plastic Pickup Tip—yellow or green, over the shiny side up primers in the Primer Flip Tray and gently pressing down. Put the other half of the Flip Tray on the ribbed half with the primers that are anvil side up. Hold the two

halves together and turn the two halves over. Remove the top half of the tray and pick up the remaining primers that are now shiny side up.



- Pivot the Primer Alarm Lever away from the Early Warning System Housing and invert the Pickup Tube over the Primer Shield Cap. Pull the Retaining Clip and allow the primers to drop into the Magazine—verify no primers remain in the Pickup Tube.



Invert Pickup Tube over Primer Shield Cap opening—remove Retaining Clip allowing primers to drop into Magazine Tube

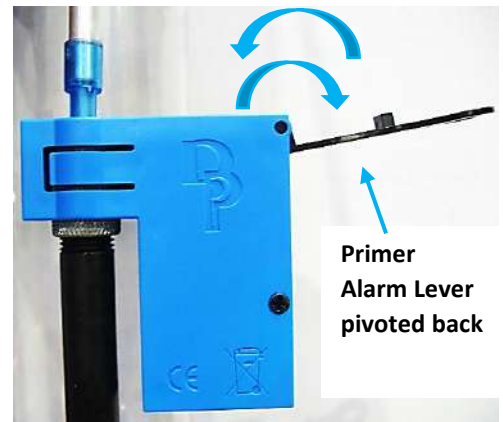

- Pivot the Switch Lever back over the hole and gently slide the Follower Rod down through the Switch Lever and into the Primer Magazine Tube. The Black Plastic Follower Rod will activate the Primer Early Warning Alarm when there are approximately three to four primers left.



Slide Follower Rod Through Lever into Magazine Tube



Primer Alarm switch activated by Rod and Lever



- The second method of filling the Primer Magazine is to use the Dillon RF100 Automatic Primer Filler that automatically loads primers in a Primer Filler/Tube Housing—see below:



Protective Housing and Dispensing Assembly— Holds 100 primers

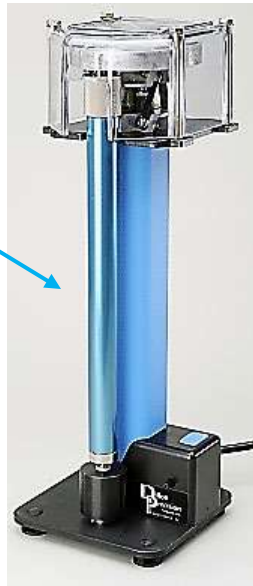

Dillon RF 100 Automatic Primer Filler

Dillon's RF 100 Automatic Primer Filler™ eliminates the task of manually filling primer pick up tubes. Pour your primers from their box into the top of the RF100. Press the blue button. In about two minutes the primers are inside the primer tube that is inside a protective metal housing. The RF100 comes in either a small or large primer version. Size Conversion Kits are also available.

RF100 Voltages	Small Primer Part No.	Large Primer Part No.
120 VAC	97111	97077
220 VAC	97113	97112

8.5 Station 2b--Powder Measure Setup--Case Mouth Expanding and Powder Dispensing (Second Operation of Station 2— During the Downstroke of the Operating Handle)



Station 2— powder dispensing and case mouth expanding

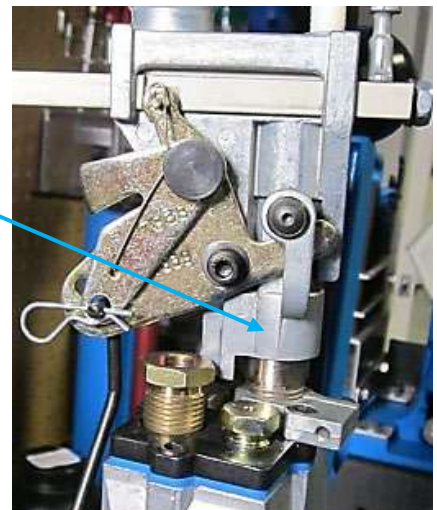

8.5.1 The Dillon Powder Measure System is a Volumetric Powder System that is activated only when there is a case present in Station #2. There are different size Powder Bars. (See below) Each Powder Bar is adjustable to control the volume of powder dispensed.

Adjustable Volumetric Powder Cavity-- Large Bar Shown

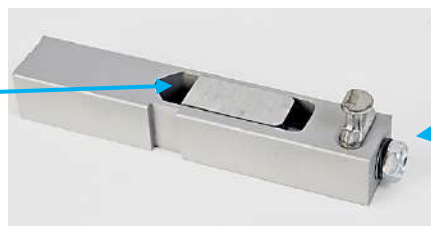

Adjusting Screw

8.5.2 The Square Deal "B" is shipped with a Small and a Large Powder Charge Bar. The Small Bar is installed in the Powder Measure. The Dillon Powder Measure uses Charge Bars that are specific to the range of powder dispensed as shown below.

Store Spacer Bar Plug in hole here when not in use

④ Spacer Bar Plug PN13921 and ③ Spacer Bar PN13664 only used with Small and Extra Small Bars

ITEM NO.	PART NUMBER	QTY.
1	POWDER BODY ASSEM	1
2	13691_HOPPER TUBE	1
3	13644_POWDER BAR SPACER	1
4	13921_POWDER BAR SPACER PLUG	1
5	11234_LOCK LINK ASSEM	1
6	13848_BELLCRANK BUSHING	1
7	10-32x1.250 SHCS	1
8	10-32 LOCKNUT ZINC	1
9	14041_250 BOWED WASHER	1
10	20062_SMALL BAR ASSEM*	1
11	13871_BELL CRANK CUBE	1
12	8x375 PHIL SHEET	2
13	13882_POWDER MEASURE HOPPER LID	1
14	BODY COLLAR ASSEM SD	1
15	20780_EXTRA SMALL BAR ASSEM*	1
16	20063_LARGE BAR ASSEM*	1

* = CALIBER SPECIFIC



Note: The Powder Measure is only activated by a cartridge case pushing up on the Powder Funnel.

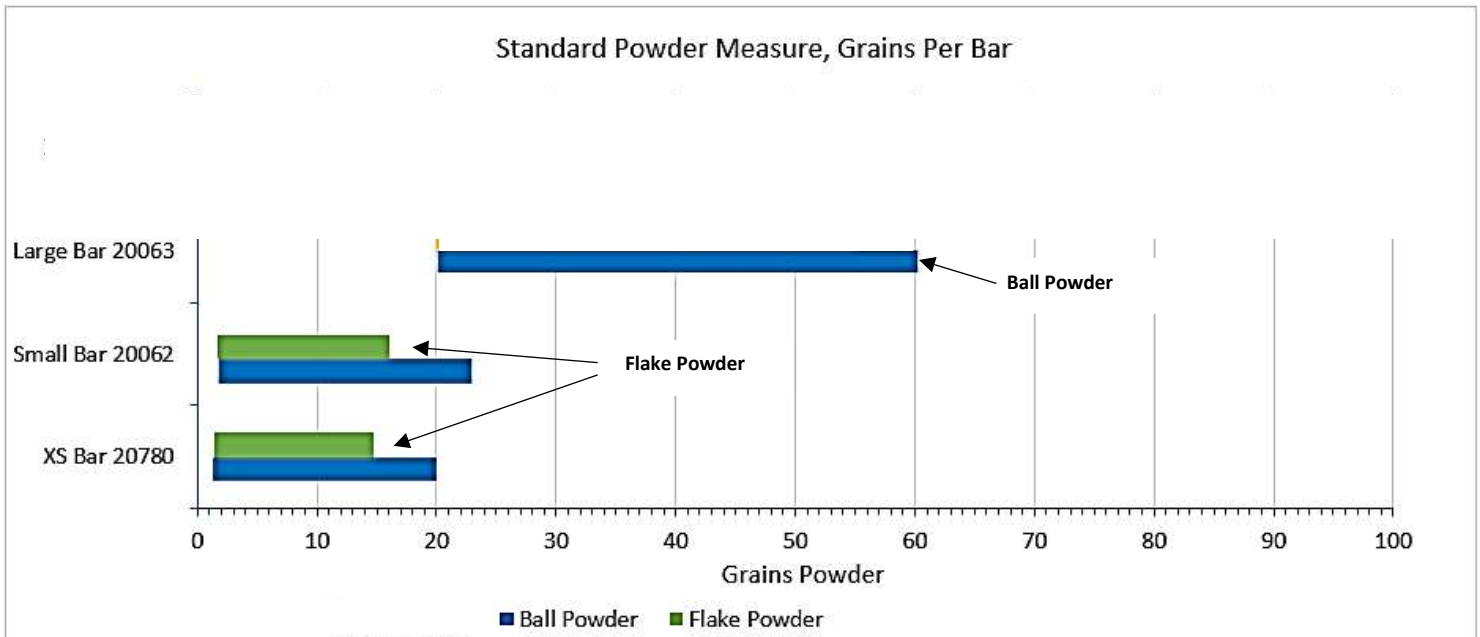

8.5.3 There are 3 adjustments required of the Automatic Powder Measure System:

- 1--Full horizontal travel of the Powder Bar--The Powder Charge Bar must be adjusted to achieve full horizontal travel. Failure to do so will result in inconsistent powder charges.
- 2--Case mouth bellng adjustment
- 3--Powder charge weight adjustment

8.5.4 Place an empty-sized case in Station 2 with no powder in the Powder Measure. Loosen the 10-24 Powder Measure Clamp Socket Head Screw with a 5/32" Allen wrench and the Powder Measure Clamp Button Socket Head Screw with a 1/8" Allen Wrench (see below). Cycle the Operating Handle fully down. Proper adjustment is achieved with the Powder Bar reaching the end of its travel at the same time the Operating Handle reaches the bottom of its stroke, as indicated by the Bellcrank Arm just touching the Powder Body as shown below. If the Bell

Crank Arm has not traveled its full distance or tries to over travel, cycle the Operating Handle up and down slightly (from the bottom of the stroke) while threading the Powder Die up/down with your fingers while holding the Powder Measure from rotating. Lightly tighten the Powder Die Clamp Screw—further adjustment is required for case belling which is discussed below.

Powder Die Clamp Screw

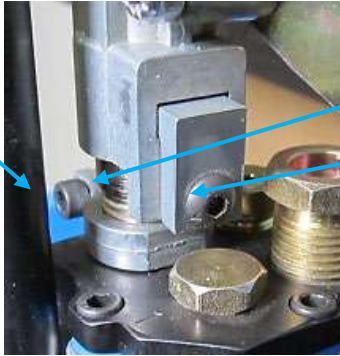

Adjusting the Powder Measure travel requires loosening the Powder Die Lock Screw the Powder Measure Clamp Screw with a 5/32" and an 1/8" Allen wrench

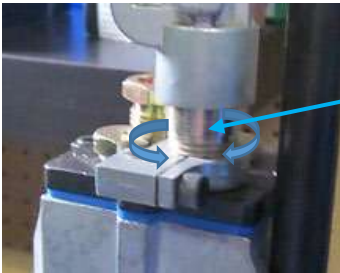

Rotate Powder Die Up or down with your fingers to achieve full travel of "Bell Crank Arm" while gently cycling the Operating Handle up and down at the bottom of the stroke with a sized case in this station

"Bellcrank Arm" must touch the Powder Body here without over travel as the Operating Handle reaches the bottom of its stroke

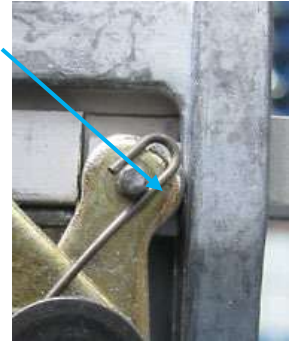

8.5.5 Belling (flaring) the case mouth--With the empty case from the previous step in Station 2, cycle the Operating Handle down and back up. Remove and inspect the case for proper belling—see below. Adjust-thread the Powder Die up/down a small amount (~1/8 turn) at a time with your fingers while keeping the Powder Measure from rotating. Place the case back in Station 2 and repeat the test until the proper amount of belling is attained. The desired amount of bell/flare is just enough to allow the bullet to sit on the case mouth without falling off/over and to keep the case from shaving bullet material, especially with lead bullets. On handgun cartridges, a sized belled (flared) case mouth diameter should measure approximately .010" larger than a sized case. Note-over flaring can be corrected by gently resizing the case in the Size Die in Station #1.)

Typical Dillon Pistol Powder Funnel

Belling taper of Powder Funnel



Powder Funnel Belling Case

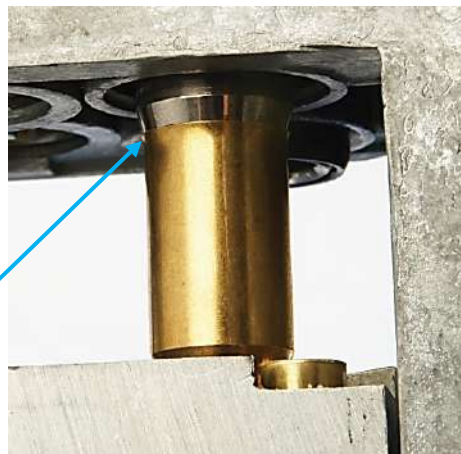

Measuring Belling



Bell case mouth just enough to allow the bullet to sit on the case mouth without falling off/over and to keep the case from shaving bullet material

No Belling

Adequate Belling

Excessive Belling



8.5.6 Powder Charge Weight Adjustment

- A scale that weighs in grains is required for this step. A Digital Electronic Scale is available from Dillon--PN10483.



- Select a powder that is specific to the bullet caliber, weight and type of bullet being reloaded. Refer to established bullet and powder manufacturers for reloading data such as Sierra, Hornady, Western Powders, or Alliant Powders and reloading manuals such as the Hodgdon or Lyman Reloading Manuals.
- Verify that the correct Powder Bar is installed in the Powder Measure for the range of powders to be dispensed.
- Select the powder charge weight in grains from the appropriate established reloading document and write it down.
- **WARNING! Put on safety glasses!**
- Remove the Powder Measure Hopper Lid and fill the Hopper with the prescribed powder and replace the Hopper Lid. Label the Hopper with tape or a sticky note as to what powder is in the Hopper.

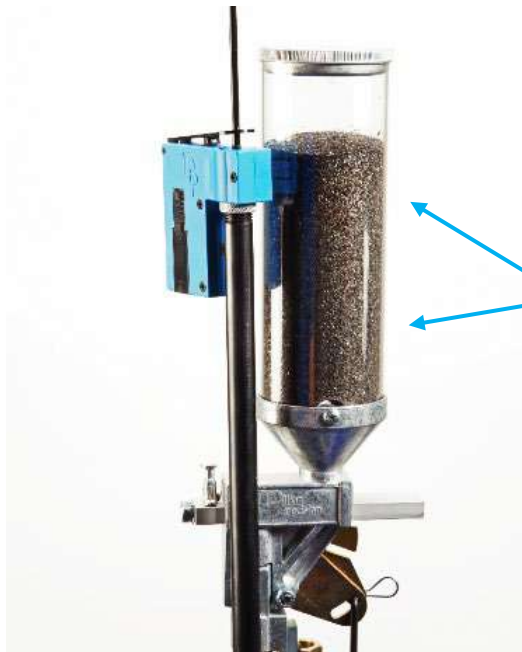

Remove Hopper Lid and fill Hopper with Powder

- Place a primed case in station 2 and cycle the Handle fully down. Remove the case and dump the powder back in the Hopper. Do this at least 5 times to stabilize the Power Measure. Now, remove the case and dump the powder in the pan on the scale. If the amount is incorrect, adjust the powder bar adjusting bolt as required--Clockwise to increase the amount and Counter Clockwise to decrease

the amount using a 7/16" wrench—see below. Measure the powder dispensed 3-4 times verifying that the dispensed amount is stable.

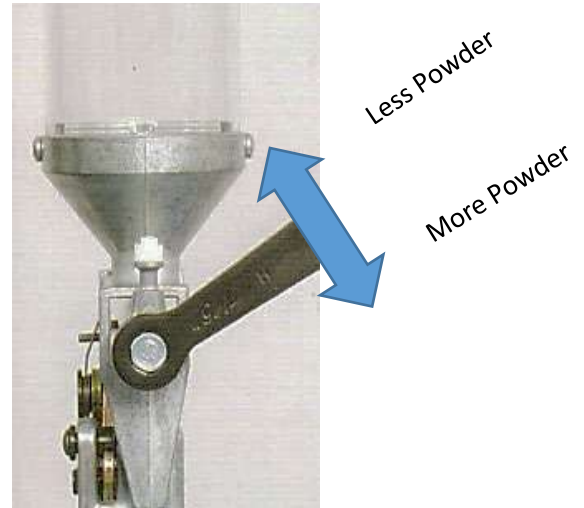
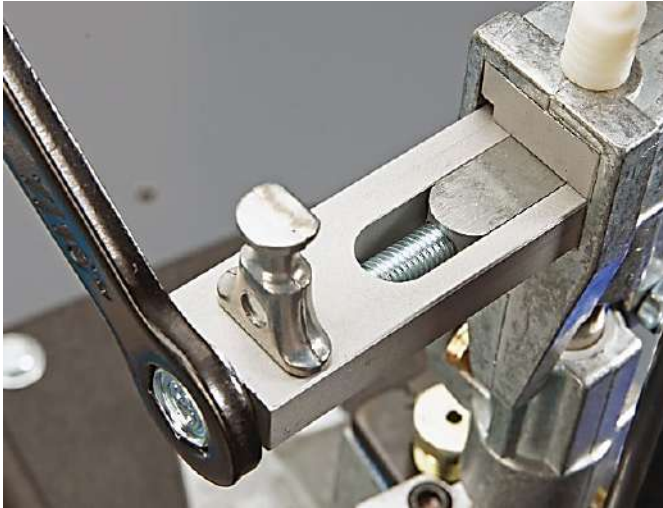

DANGER! WARNING!

- **POWDER BURN RATES ARE SIGNIFICANTLY DIFFERENT BETWEEN POWDERS FOR RIFLES AND PISTOLS.**
- **USING THE WRONG POWDER (PISTOL POWDER) IN A RIFLE FOR EXAMPLE) OR AMOUNT OF POWDER OR MIXING POWDERS CAN RESULT IN SERIOUS INJURY OR DEATH.**
- **ALWAYS STORE POWDER IN ITS ORIGINAL CONTAINER.**
- **NEVER MIX POWDERS.**
- **NEVER HAVE MORE THAN ONE TYPE OF POWDER IN THE RELOADING AREA AT ONE TIME.**
- **OBSERVE ALL MAXIMUM LOAD WARNINGS. (MAXIMUM LOADS MAY NOT BE SAFE IN YOUR FIREARM.)**
- **NEVER LEAVE POWDER IN THE POWDER MEASURE**

- **Typical Powder Shapes:**



Flake and perforated disk

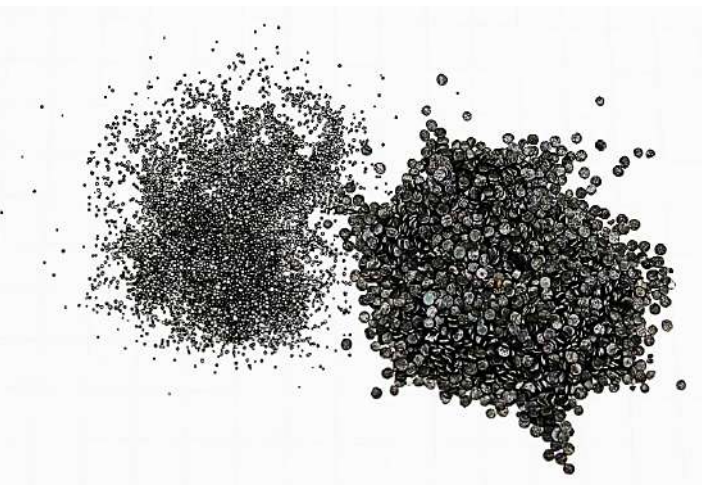

Ball and flattened ball powders

8.6 Station 3--Bullet Seating Setup Cartridge Overall Length (COAL)

8.6.1 The Seating Die pushes the bullet into the case. How far the bullet is pushed into the case will determine the cartridge overall length--COAL. The maximum cartridge overall length depends on the following factors:

- Most loading manuals provide the COAL based on SAAMI (Sporting Arms and Ammunition Manufacturers' Institute) standards.

- The cartridge overall length specified in the reloading manuals for a cartridge is usually the minimum length for that bullet/powder charge combination. **WARNING! Avoid loading shorter than the minimum specified length.** This will seat the bullet deeper into the case which decreases the case volume and increases the pressure. This may cause an overpressure condition, especially in pistol cartridges.
- The bullet must be seated deep enough into the case to provide enough “hold/grip” on the bullet.
- The bullet should not contact the rifling/lands in the barrel when the cartridge is chambered. **WARNING! --seating bullets into the lands can cause an overpressure condition!**
- The cartridge must fit the firearm’s chamber or magazine (if it has one).
- The bullet may have a cannelure(s) or a crimping groove that may be used to determine the proper COAL.

8.6.2 Installation of the Seating Die

- The Square Deal Seating Assembly consists of a Die Body that drops into the frame and an adjustable Seating Stem that threads into the Shellplate. The Square Deal is shipped with one Seating Stem installed and the other shipped separately. There is a third stem included for .38/.357 “wadcutter” bullets.

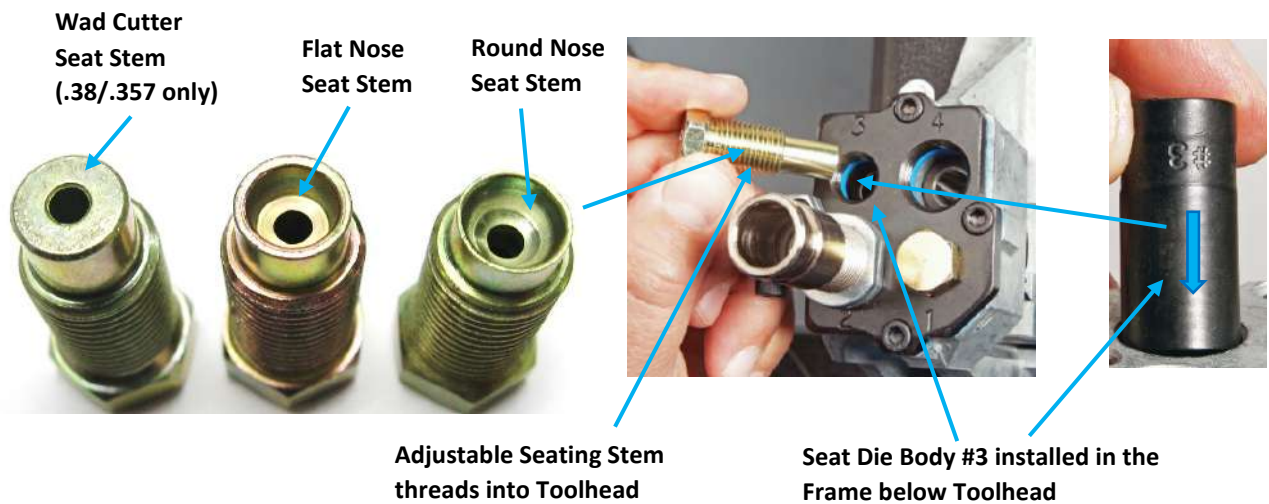

- Select the Seating Stem that matches the nose of the bullet being seated.
- Thread the Stem into Station #3 on the Toolhead using the Bench Wrench or a 9/16” Wrench. Start with the Stem 5 turns down. At this point, the Die will not be down far enough to begin seating the bullet.

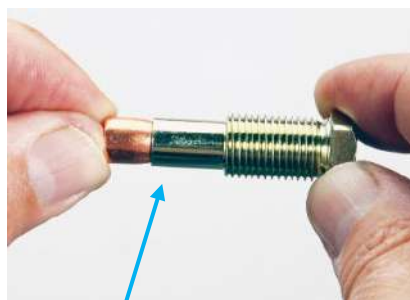

Select the Stem that best fits the nose of the bullet



Thread Stem into Station #3 using the Bench Wrench or a 9/16” Wrench 5 turns down—further adjustment is required



8.6.3 Adjustment of the Seating Die

- Determine the overall cartridge length (COAL) required in your reloading manual.
- Place a belled case into Station 3. Place a bullet on the belled case mouth and lower the Handle. Then, raise the Handle just enough to remove the cartridge. Use a dial caliper to measure the cartridge overall length (COAL). If the bullet is not seated deep enough, screw the Seating Die down 1/2 turn at a

time which is about .025". As a guide, one full turn changes the seating depth about .050", about the thickness of a dime. Replace the cartridge in Station 3 and repeat these steps until the COAL is achieved.



8.7 Station 4--Bullet Crimping

8.7.1 Crimping is the final operation in the reloading process in Station 4. Crimping removes the belling of the case mouth from the previous neck expanding or belling step. Crimping provides added friction for "holding" the bullet by the case.

8.7.2 There are two types of crimping--the roll crimp and the taper crimp. In general, taper crimping is used for semi-autos with rimless cartridges and roll crimping for revolvers with rimmed cartridges. Excessive crimping can "buckle" the cartridge case as shown below.

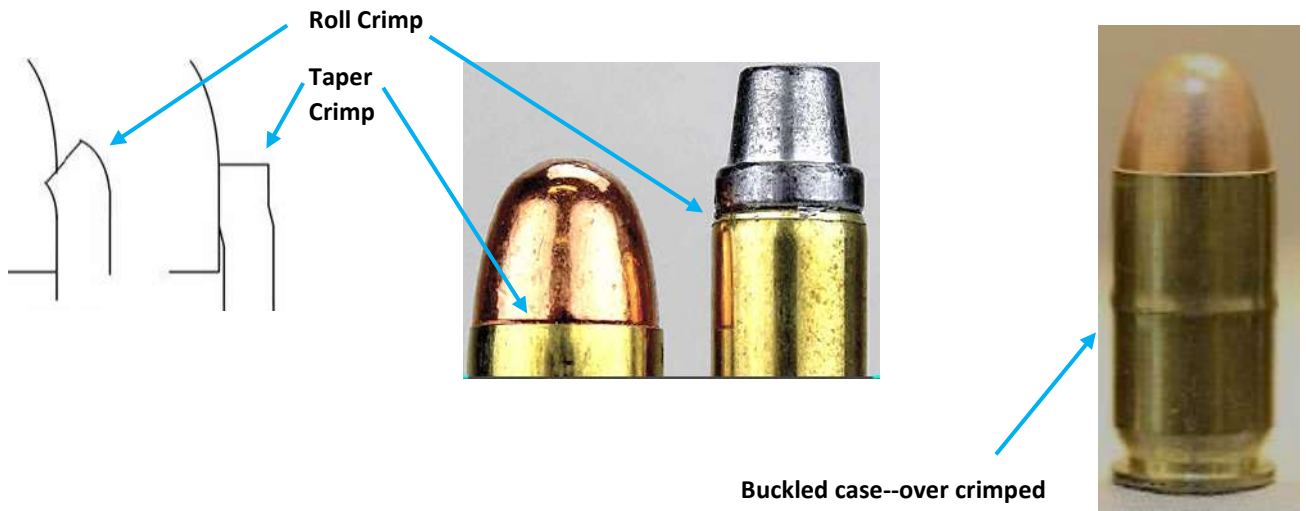

8.7.3 Roll Crimping—Generally for revolver cartridges

- The edge of the case mouth is rolled inward into the bullet during roll crimping, leaving a slight radius at the top of the case mouth. Cast lead bullets or jacketed bullets may or may not have a crimp groove or a cannelure that accepts the roll crimp. If there is no groove or cannelure, take care not to over crimp the bullet. Over crimping can damage the bullet and reduce the "hold" on the bullet due to the bullet being deformed and the brass case springing back away from the deformed bullet. Crimping a bullet without a crimp groove should only reduce the diameter of the brass case mouth/outer diameter .001-.003" maximum. A reduction of case mouth diameter greater than .003" may cause bullet deformation and a loose bullet. It is not necessary to use the cannelure if your COAL is not compatible with the location of the cannelure.

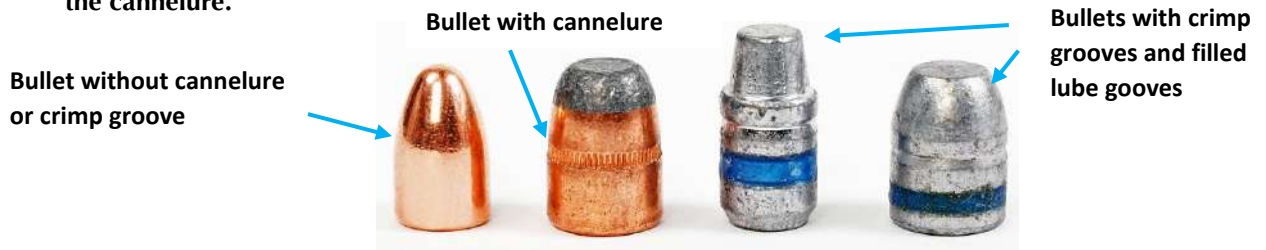

- Roll crimping a revolver bullet provides the extra hold between the bullet and the case to prevent the bullet from being “pulled” out of the case during recoil. This can cause the revolver’s cylinder to lock up after a few shots if a bullet is “pulled” far enough out of the case to contact the frame.

8.7.4 Taper Crimping—Generally for semi-auto cartridges

- A taper crimp flattens out the belling of straight wall semi-auto pistol cases from the previous step. Rimless straight-walled or tapered cases such as the 9mm, .40 S&W and .45 ACP cartridges headspace on the case mouth and roll crimping and excessive crimping can shorten the cartridge case causing improper head spacing in the chamber. Taper crimping is also used on bullets without a cannelure or a crimp groove.
- The gradual taper in the top of the taper Crimp Die should only reduce the diameter of the top edge of the case mouth .001-.003”.

8.7.5 Installation of the Square Deal Pistol Crimp Die

- The Crimp Die consists of a Crimp Die Body that drops into the Frame and a hollow Universal Crimp Adjuster Plug that threads into the Toolhead that adjusts the Crimp Die body up and down varying the amount of crimp. Thread the Crimp Plug in four turns as a starting point.



Insert Crimp Die Body #3 here

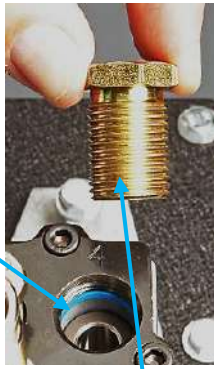

Install Universal Crimp Adjuster Plug in Station #4



Thread Crimp Plug in 4 turns as a starting point

8.7.6 Adjustment of the Square Deal Pistol Crimp Die

- Place the cartridge from the seating step in Station #4 and cycle the Operating Handle down and raise it just enough to remove the crimped cartridge. Measure the amount of crimp and repeat until the desired amount of crimp is achieved
- Pistol cartridge caliber-specific case gauges are available from Dillon and replicates the SAAMI chamber specification. They provide a quick check of the cartridge's crimp, diameter and case length. If the reload fits in the case gauge, it usually fits in the gun’s chamber.

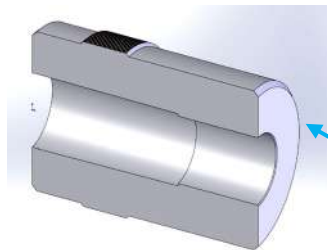

Dillon Pistol Case Gauge



9. CONVERSION AND REPLACEMENT PROCEDURES

9.1. Dillon has conversion kits for various calibers as noted in the table below:

Conv. #	Caliber	SDB Shellplate	Locator Buttons	Powder funnel	SDB Crimp Die	SDB Seat Stem	SDB Seater Die	SDB Sizer Die
16774	32 S&W Long, H&R Mag	D (12507)	3 (14060)	S (12845), SW (13171)	32 S&W (16544)	32 S&W WC (16775), 32 S&W RN (16824)	32 S&W (16543)	32 S&W (22222)
20246	380 ACP	3 (12906)	3 (14060)	F (13806)	380 Auto (11870)	9mm SWC (11302), 9mm RN (12313)	380 Auto (12198)	380 Auto (22207)
20240	38 Special / 357 Magnum	2 (13635)	2 (14062)	D (13599)	38/357 (12279)	38/357 SWC (12158), 38/357 WC (11647), 38/357 RN (11429)	38/357 (12673)	38/357 (22201)
20229	38 Super (only)	5 (13440)	3 (14060)	F (13806)	38 Super (12473)	9mm SWC (11302), 9mm RN (12313)	38 Super (12345)	38 Super (22208)
20275	38 Super Comp	3 (12906)	4 (14060)	F (13806)	39 Super (12473)	9mm SWC (11302), 9mm RN (12313)	39 Super (12345)	39 Super (22208)
20241	9mm Parabellum (only)	5 (13440)	3 (14060)	F (13806)	9mm Parabellum (12497)	9mm SWC (11302), 9mm RN (12313)	9mm Parabellum (11525)	9mm Parabellum (22206)
20469	.40 S&W/10mm	W (13523)	2 (14062)	W (13600)	40/10mm (11801)	40/10mm TRUN (11048), 40/10mm SWC (12124)	40/10mm (12776)	11534 Body/ 15047 Carbide
20247	41 Magnum	6 (13284)	1 (13930)	H (13240)	41 Magnum (11799)	41 Magnum SWC (12067)	41 Magnum (11794)	41 Magnum (22202)
20242	44 Special	4 (13504)	4 (14047)	G (13427)	44 Spl / 44 Magnum (13036)	44 Magnum SWC (11880), 44 Magnum RN (12571)	44 Spl / 44 Magnum (11863)	44 Spl / 44 Magnum (22203)
21035	44-40 Winchester	N (13095)	4 (14047)	4 (13474)	44-40 Winchester (10847)	44 Magnum SWC (11880)	44-40 Winchester (10722)	44-40 Winchester (10853)
20123	45 ACP / 45 GAP	1 (13653)	1 (13930)	E (13782)	45 ACP / 45 GAP (11734)	45 ACP SWC (11303), 45 ACP RN (12476)	45 ACP / 45 GAP (11628)	45 ACP / 45 GAP (22204)
20248	45 COLT	C (13112)	4 (14047)	E (13782)	45LC (12588)	44 RN (12571), 45 COLT SWC (12619)	45 LC (11733)	11733 BODY/15054 Carbide
20417	45 S&W Schofield	C (13112)	4 (14047)	E (13782)	45 Schofield (11253)	45 Schofield RN (11210)	45 Colt (12306)	45 Colt (22205)

9.2. Caliber Conversion Procedure

9.2.1 Obtain a Caliber Conversion Kit from the above list. The contents of a typical Square Deal "B" Caliber Conversion Kit are shown below.

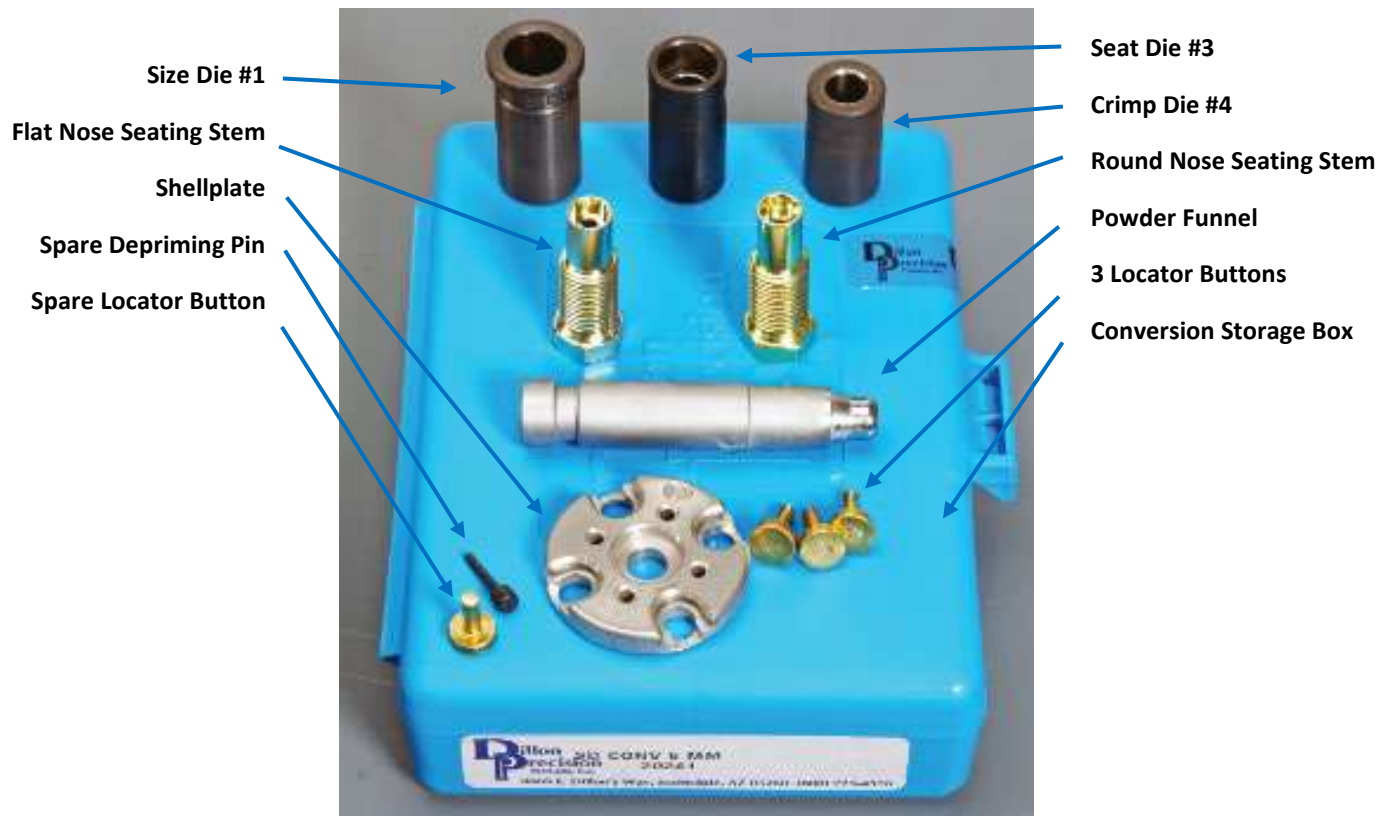

Square Deal Conversion Kit

9.2.2 Shellplate Conversion Procedure

- Replace the Shellplate by first removing the three Brass Locator Buttons. Gently pull up on the Cartridge Ejector Wire and rotate it out of the way of the Shellplate. Loosen and remove the Shellplate Shoulder Screws with a 1/8" Allen wrench. Remove the Shellplate. Check the area under the Shellplate and the Index Ball and Spring for debris and clean as necessary.



Brass Locator Buttons and store in Blue Conversion Box



Gently pry up and rotate the Ejector Wire to the side as shown

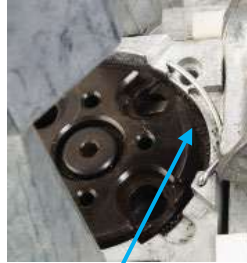

Remove Shellplate Bolt and Shellplate and store in the Conversion Box



Clean the area under the Shellplate and the Index Ball and Spring



- Replace the Shellplate making sure the Index Spring and Ball are still in place. Tighten the Shellplate Bolt down snug. Reposition the Ejector Wire. Make sure the Ejector Wire is not dragging on the Shellplate and the Shellplate turns freely.

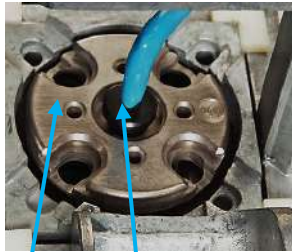

Install new Shellplate Tighten Shellplate Bolt just snug with an Allen Wrench



Reinstall Injector Wire

Install new Brass Locator Buttons from the Conversion Kit

9.2.3 Primer Size Conversion

- The Square Deal "B" comes with both Small and Large Priming Components. The size of the Primer Slide specific for the cartridge order is installed and the alternate size is shipped separately.
- The Magazine Tube Assembly uses color-coded plastic Primer Magazine Feed Tips. The Large Prime Magazine Tip is red and Small Primer Magazine Tip is blue. The Aluminum Magazine Small and Large Tubes have different inside diameters. A Conversion Kit for the alternate size primer is included in the "Tube Pack."

Large Primer Pickup Tube—Green Tip (Yellow Tip is Small)



Large Primer Magazine Tube/Orifice Tip—Red Tip (Blue Tip is Small)

Small Primer Slide with Gold Cup PN20125

Small Primer Cup with Silver Cup—PN20124

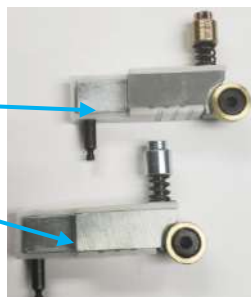

Small Primer Magazine--Blue Tip



Large Primer Magazine--Red Tip

- Remove the Primer Assembly by lowering the Operating Handle down, and removing the three 10-24 Socket head Screws with a 5/32" Allen Wrench that fasten the Primer Assembly to the frame.

3 Primer Assembly Mounting Screws— Note— the top screw is longer than the other two

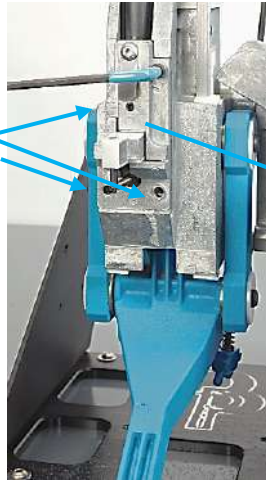

- Remove the Rod and “pour out” any primers left in the Magazine Tube. **WARNING!-any primers left in the Magazine Tube will fall out inside the Magazine Shield when you pull the Primer Magazine tube out.**
- Remove the knurled Primer Shield Cap from the Primer Magazine Assembly and, pull the Magazine Tube assembly straight up out of the Magazine Shield.



Remove Shield Cap and pull Magazine tube out of the Magazine Shield Tube



- Insert the alternate Magazine Tube Assembly of the appropriate size--Red or Blue Tip into the Magazine Shield and gently rotate the Magazine Tube until the tab on the Plastic Tip engages the slot down in the Primer Feed Body, allowing the Magazine Tube Assembly to drop into place. Replace the Primer Shield Cap, making sure the top of the Magazine Tube goes into the bore inside the Cap. Tighten the Cap just snug. Do not overtighten.

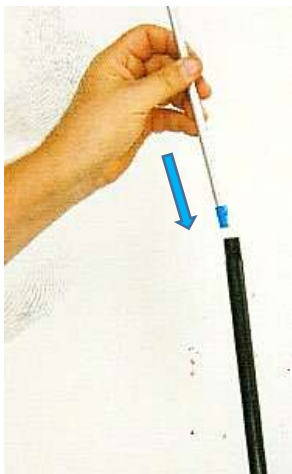

Slot in Feed Body for Magazine Tip

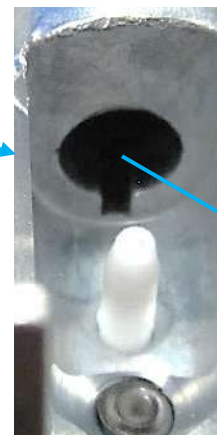

- Retrieve the alternate Primer Slide Assembly. Disconnect the Primer Slide return Spring by rotating the Primer Slide Assembly clockwise to disengage it from the Primer Slide Body

Disconnect the Return Spring

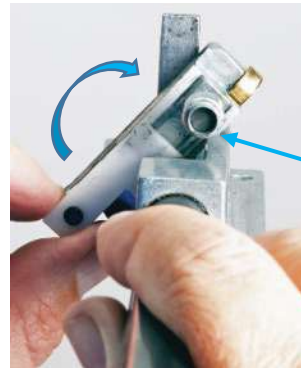
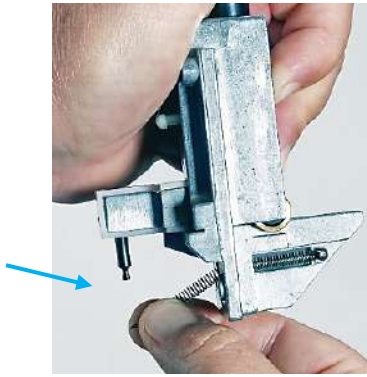

Remove the Primer Slide Assembly by rotating it clockwise

- Install the replacement Primer Slide Assembly by rotating it into place as shown below. Re-attach the return spring and remount the Primer Assembly to the Square Deal with the 3 Screws previously removed.

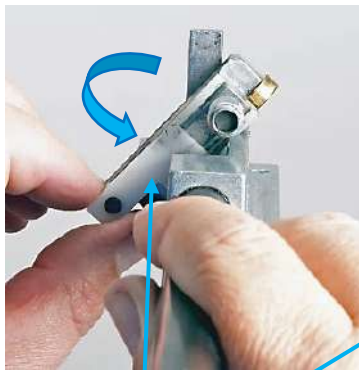

Install the replacement Primer Slide Assembly by rotating it into position as shown



Re-connect the Return Spring

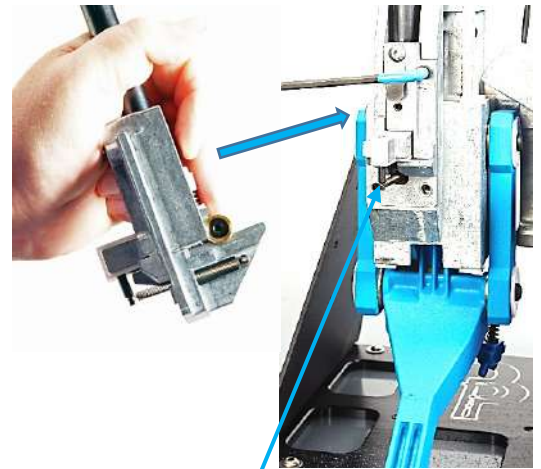

Re-attach the Primer Assembly with the 3 Mounting Screws—Note— the top screw is longer than the bottom two

- Gently cycle the Operating Handle to the priming position—full push stroke to the rear, to make sure there is no binding of the Priming Cup in the Shellplate and the Shellplate indexes properly.

9.3. Die Caliber Conversion Procedure

- Remove the Powder Measure by removing the Spring Clip from the Fail-Safe Rod and disconnecting the Rod from the Powder Measure. Put the Spring Clip back in the Rod-end for safekeeping.

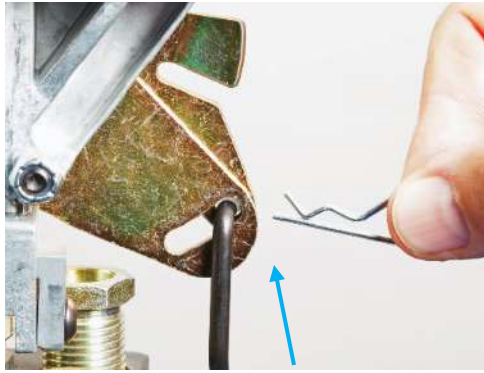

Remove the Spring Clip and disconnect the Failsafe Rod from the Lock-link Assembly

Store the Spring Clip in the Failsafe Rod

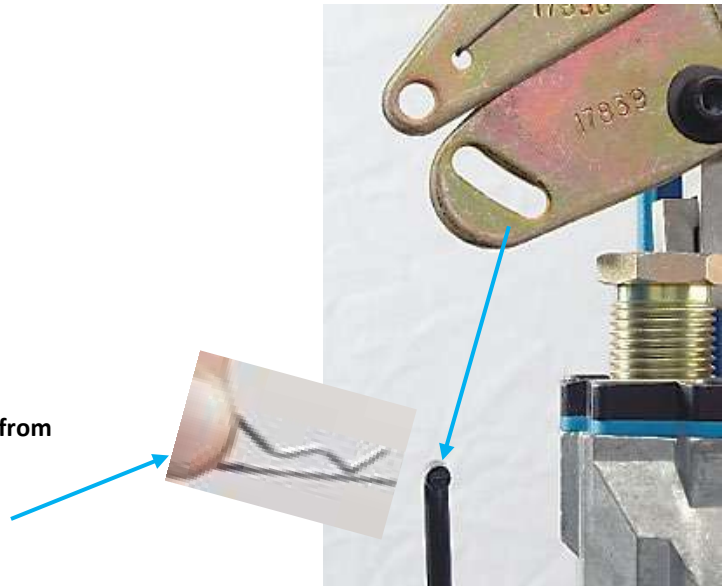

- Remove the Powder Measure Clamp Screw, Clamp and lift the Powder Measure up and off the Powder Die. Empty the Powder in the Powder Measure into the original container cycling the Powder Measure right side up and upside down.



Remove the Powder Measure Clamp



Slide the Powder Measure up off the Powder Die

- Remove all four of the 10-24 Socket Head Toolhead Mounting Screws and remove the complete Toolhead Assembly exposing the Dies.

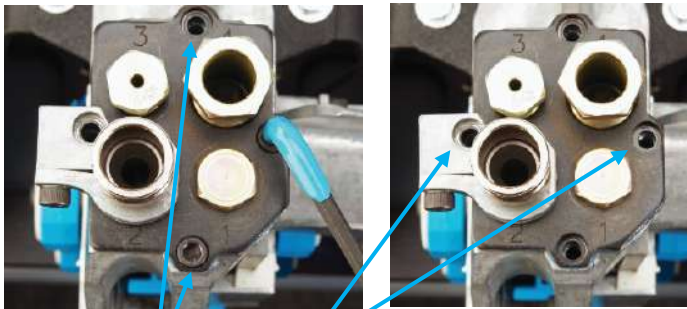

Remove all four Toolhead attachment screws with a 5/32" Allen wrench

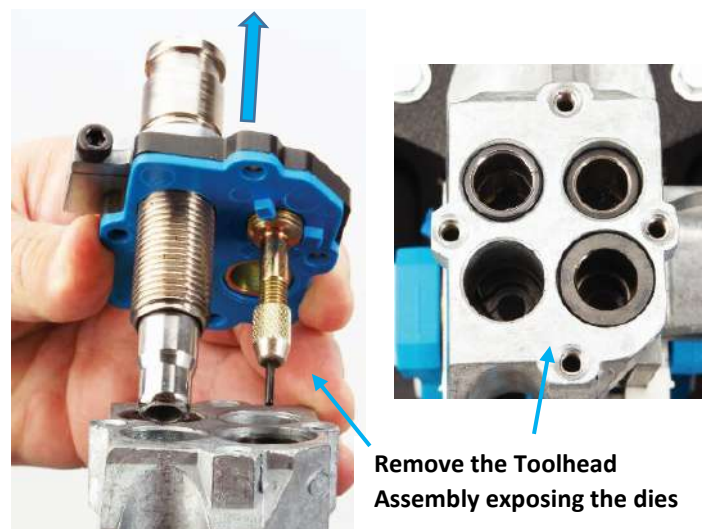

Remove the Toolhead Assembly exposing the dies

- Remove the Size, Seat and Crimp Die by pushing each one from the bottom with your finger.



Remove the Size Die from Station #1



Remove the Seat Die from Station #3



Remove the Crimp Die from Station #4

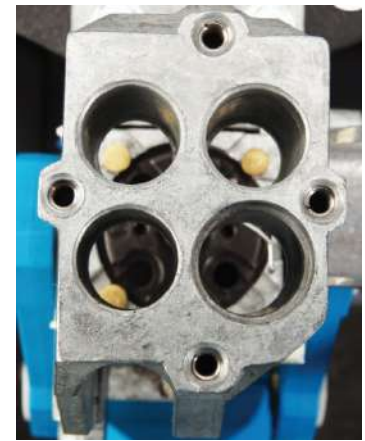

All Die Bodies removed

- Replace the Size, Seat and Crimp Dies--The Dies are numbered #1-Size Die, #3-Seat Die and #4-Crimp Die. They drop into the Square Deal Frame in Stations #1, #3 and #4 as shown below.



Insert Size Die in Station #1



Insert Seat Die in Station #3



Insert Crimp Die in Station #4

- The following parts are universal and used with every caliber conversion. The Blue Friction Plate is sandwiched between the Frame below and the Toolhead above. The Friction Plate keeps the treaded adjusting parts of the dies from turning easily.

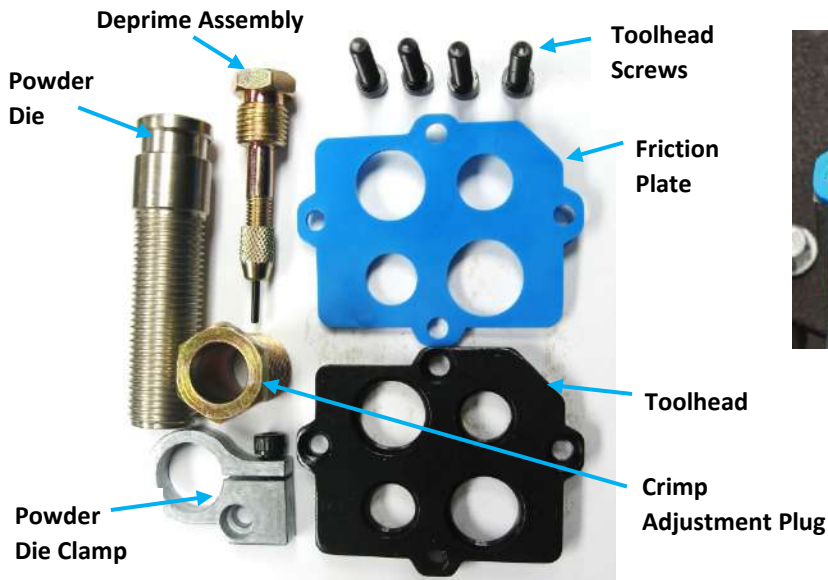

Place the Friction Plate on the Frame and then the Toolhead on the Friction Plate

- Tighten the Toolhead to the Frame with three of the Toolhead Screws with a 5/32" Allen Wrench. Thread the Depriming Assembly into Station #1 and tighten it against the Toolhead.

Install three 10-24 SHCS Toolhead Screws

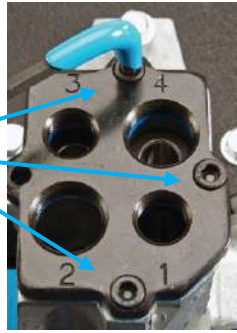

Thread the Depriming Assembly flush against the Toolhead using the Square Deal Bench Wrench or a 9/16" Wrench

- Insert the Powder Die into the Powder Die Clamp and thread the Powder Die into Station #2 on the Toolhead leaving approximately nine threads above the Clamp. Tighten the Clamp down to the Toolhead with the last Toolhead Screw. It may be necessary to spread the clamp with a flat screwdriver to thread the Powder Die into the Toolhead.



Thread Powder Die into the Toolhead

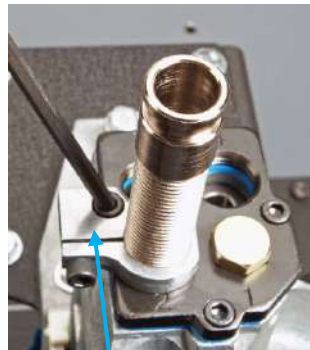

Tighten Clamp down to the Toolhead

Screwdriver blade spreading Clamp if necessary



Thread Powder Die into Toolhead—leave nine threads above the Clamp as a starting point



Put Powder Funnel into Powder Die

- Each Conversion Kits includes a Seating Stem for Round Nose and Flat Nose Bullets. A few Conversion Kits will also include a Seat Stem for a Wad Cutter. Select the Seat Stem that best fits the nose of the bullet being used. Install the adjustable Seat Stem by threading it into Station 3 of the Toolhead five turns down as a starting point.

Wad Cutter Seat Stem- (.38 Special)

Flat Nose Seat Stem

Round Nose Seat Stem



Select the Stem that best fits the nose of the bullet

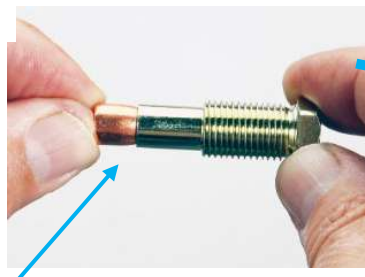

Thread Stem into Station #3 using the Bench Wrench or a 9/16" Wrench five turns down as a starting point



- Thread the Crimp Adjustment Plug into Station #4 of the Toolhead four turns down as a starting point.



Thread the Crimp Adjustment Plug into Station #4 using the Bench Wrench or a 3/4" Wrench four turns down as a starting point—further adjustment is required

- Reinstall the Powder Measure by sliding the Powder Measure down over the Powder Die and securing it with the Powder Measure Clamp/Screw. Secure the Failsafe Rod to the Lock Link Assembly with Spring Clip.



Slide the Powder Measure down over the Powder Die and secure it with the Powder Measure Clamp-Screw

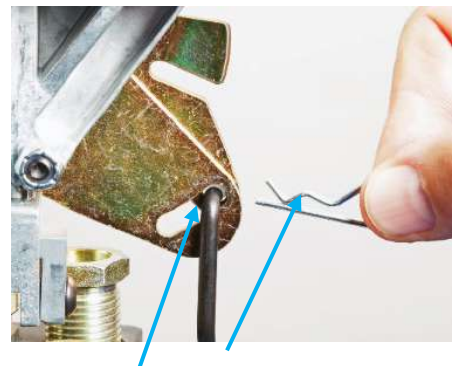

Reconnect the Failsafe Rod to the Powder Measure and secure it with the Spring Clip

- Install three numbered Locator Pins from the Conversion Kit

Install three numbered Locator Pins



9.4. Powder Measure Conversion Procedure—Small to Large Bar—the Square Deal “B” ships with a small bar

- First, loosen the Powder Measure Clamp, remove the Clip from the Failsafe Rod and pull the Rod out of the Lock Link Assembly hole and slot. Lift the Powder measure up and off the Powder die and dump all the powder out of the Powder Hopper, cycling the Powder Measure right side up and upside down.



Remove the Powder Measure Failsafe Rod Spring Clip and Failsafe Rod

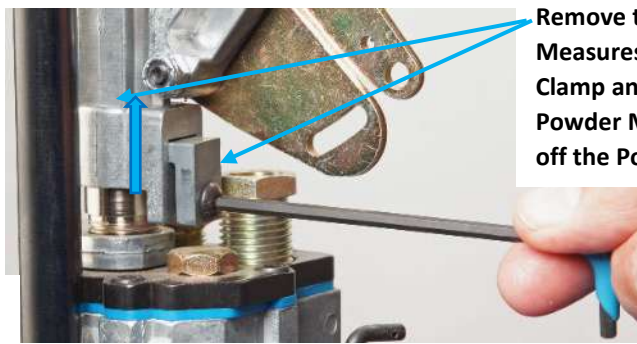

Remove the Powder Measures Screw and Clamp and lift the Powder Measure up off the Powder Die

- Loosen the Pivot Screw and Self-Locking Locknut that attaches the Lock Link Assembly to the Powder Measure just enough to disengage the Drive Pin from White Plastic Bell Crank “Cube” in the Powder Bar slot.



Self-locking Locknut on back of Pivot Screw



Loosen the Pivot Screw and Self-Locking Locknut on the back using a 7/16” wrench and a 5/32” Allen wrench.

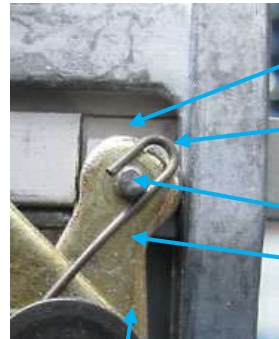

Powder Bar Drive Slot
Bell Crank White Cube
Drive Pin
Bell Crank

Gently disengage the Drive Pin in the Bell Crank and White Plastic “Cube” from the slot in the Powder Bar

- Remove the Spacer Bar Retainer Plug and slide the Spacer Bar and Powder Bar and Spacer out of the Powder Measure.



Remove the Retainer Plug and Slide the Powder Bar Spacer out

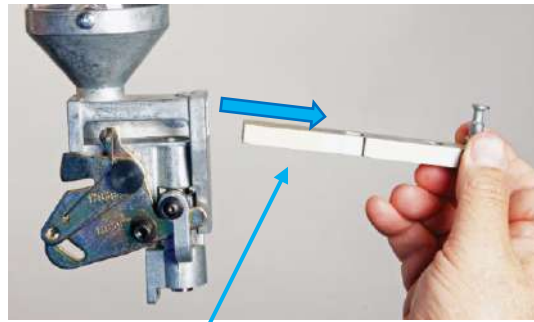
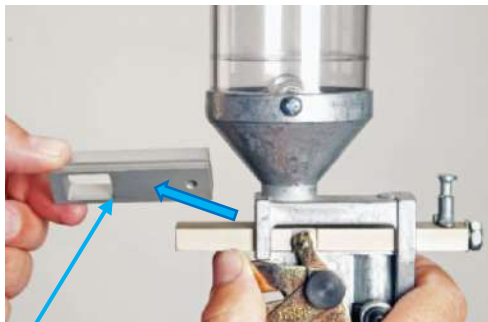

Slide Powder Bar out of the Powder Measure

- Slide the replacement Powder Bar into the Powder Body by pushing out on the Drive Pin and White Cube with your finger to engage the drive slot in the Powder Bar.

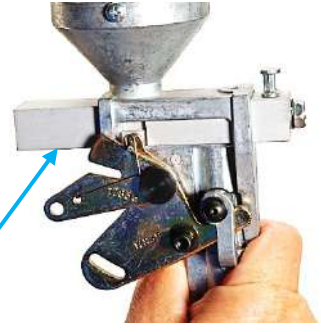
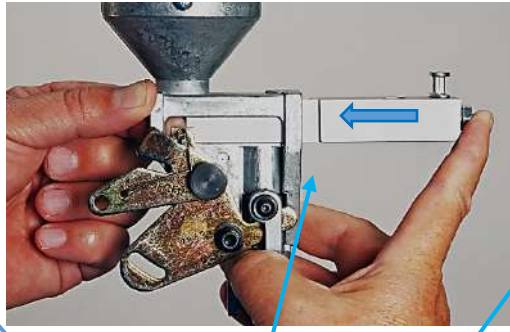

Push out on the Drive Pin and "Cube" while pushing the Powder Bar into the Powder Measure to engage the Powder Bar Drive Slot

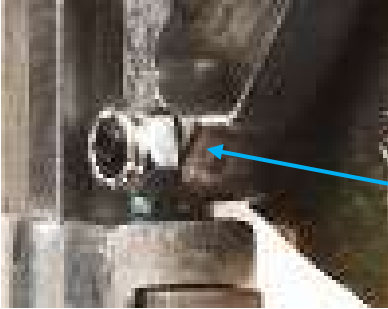

Re-tighten the Pivot SHCS and the Self-Locking Nut—do not over tighten—check that the Lock Link Assembly moves freely back and forth



- Verify that the Powder Funnel is still inside the Powder Die and Slide the Powder Measure down over the Powder Die and tighten the Clamp. Re-connect the Failsafe Rod and Spring Clip.



Gently slide the Powder Measure down over the Powder Die and secure it with the Powder Measure Clamp and Screw



Re-install the Failsafe Rod and the Spring Clip

9.5. Replacing the Depriming pin in the Depriming Assembly

- The Depriming Pin can be broken by foreign objects inside the case such as rocks, smaller cases or Berdan cases. The Pin is easy to replace.
- Remove the Deprime Assembly from the Toolhead. Hold the 9/16" hex with a Square Deal Bench wrench or a 9/16" wrench and unscrew the Knurled Nut holding the Priming Pin in place with a pair of pliers or Vice Grips. Replace the Pin (spares available from Dillon) or use the spare in the Conversion Kit Box and retighten the Knurled N with the pliers.

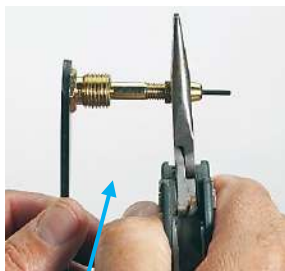

Use the Square Deal Bench Wrench or 9/16" end wrench and a pair of pliers to unscrew the Nut retaining the Depriming Pin

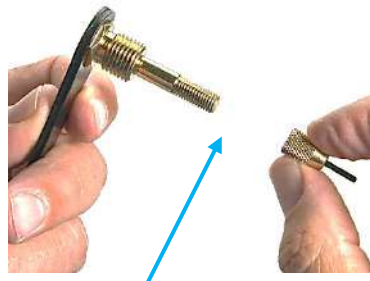

Replace the Depriming Pin and retighten the Knurled Nut



Depriming Assembly

9.6. To Replacing The Battery In The Primer Early Warning System.

- Slide the Black Cover down and replace the AAA battery inside and slide the Black Sliding Cover back up into position.

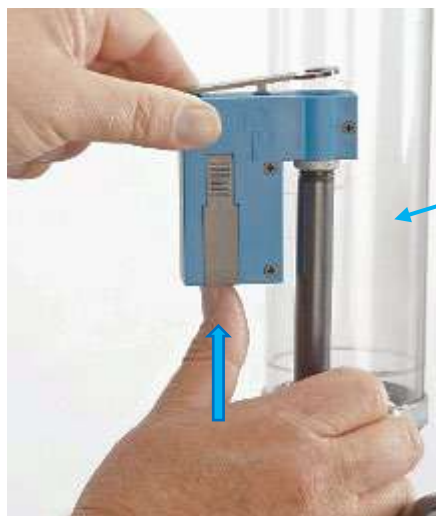

- Slide cover down
- Replace the AAA Battery
- Slide cover back up

10. ADJUSTMENT PROCEDURES

10.1. Shellplate to Primer Feed/Toolhead Alignment and Indexing

- **CAUTION!** The Base Disc (13690) and the two Base Disc Mounting Screws (13860 shown below) are factory aligned and should not require service nor should be loosened or removed from the Square Deal Frame. Doing so may require that the Square Deal be returned to Dillon for re-alignment.

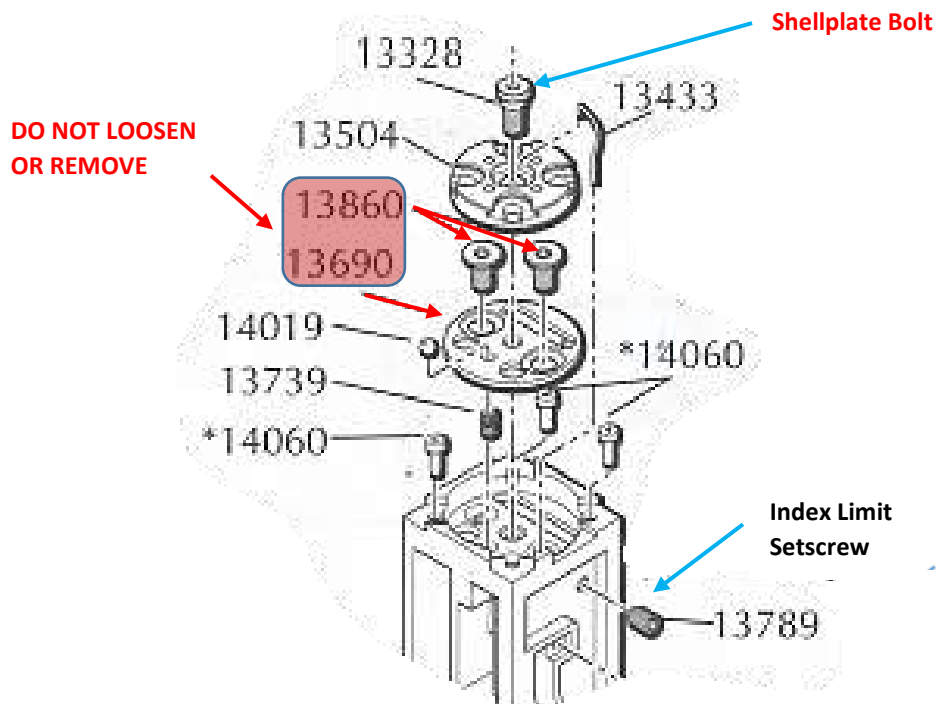

- *Before doing any adjustments to the Indexing or Priming System, verify that the Shellplate bolt 13328 above, is securely tight and the Primer Slide is assembled correctly and to the proper height as shown below:*

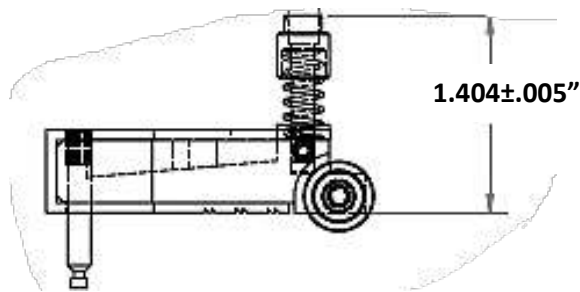

- Verify the Primer Cup to Shellplate alignment by Cycling the Operating Handle up and pushing it fully to the rear. The Primer Cup (Silver or Gold) should rise into the Shellplate without interference (“catching—indicated by a snapping sound”). The cup should be concentric with the hole in the Shellplate as shown below. Test all four positions in the Shellplate.

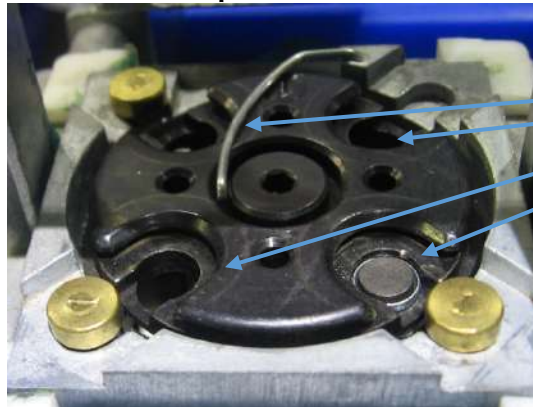

The Cup should not drag or catch on the Shellplate --check all four pockets

- If necessary, the first adjustment is to verify that the Forward Position Primer Slide Stop Set Screw for the Primer Slide Assembly. If the Primer Cup is too far forward and interfering/ “catching” on the front edge of the hole in the Shellplate, back the set screw up until the cup is centered. If the Primer Cup is too far back and “catching” on the back edge of the Primer Cup and the back edge of the hole in the Shellplate, adjust the set screw in until it is centered and not “catching.” Note, the Shellplate alignment with the Handle in the at-rest-position is controlled by the Index Ball and Spring under the Shellplate and is factory set and not adjustable.

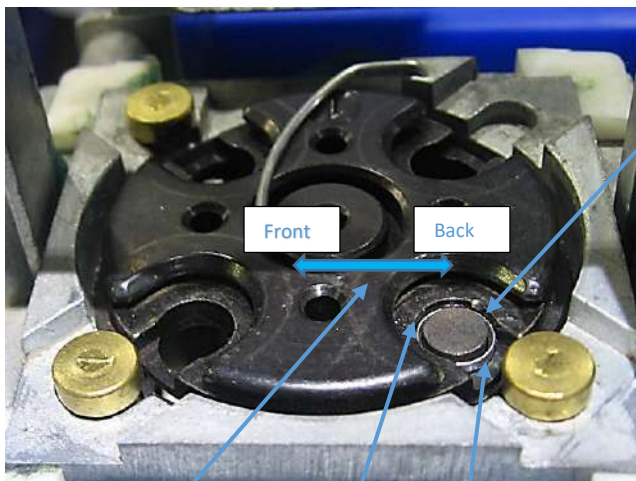

Front to Back Front Edge Back edge

Primer Cup slides smoothly into Shellplate without “catching” in the hole in the four Shellplate



Forward Position Primer Slide Position Stop Set Screw

- If the Primer Cup is catching on the right edge of the Cup in any of the 4 Shellplate pockets as the Handle is cycled fully up, the Shellplate is over-indexing. Adjust the Index Set screw in a ¼ of a turn and check all four Shellplate positions again. Repeat until there is no interference between the Cup and the Shellplate. Make small adjustments only. Again, the Shellplate alignment with the Handle in the at-rest-position is controlled by the Index Ball and Spring under the Shellplate.

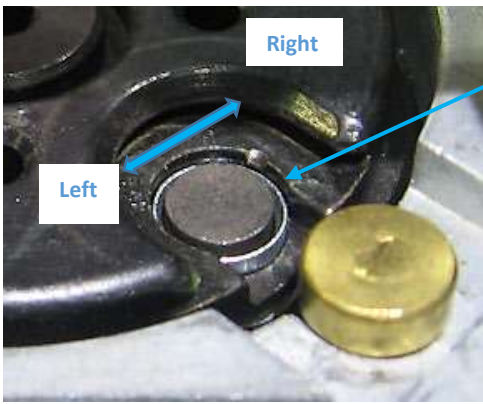

Primer Cup catching on right edge of Shellplate is over indexing—turn screw in $\frac{1}{4}$ turn

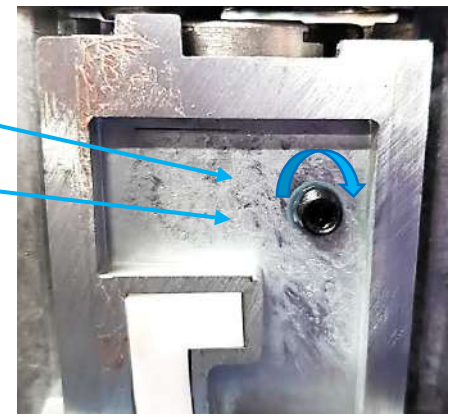

Index Limit Setscrew—turn in to shorten indexing--clockwise

- If the Primer Cup is catching on the left edge of the Cup as the Handle is cycled fully up, the Shellplate is under-indexing. Adjust the Index Set screw out $\frac{1}{4}$ of a turn and check all four Shellplate positions again. Repeat until there is no interference between the Cup and the Shellplate.

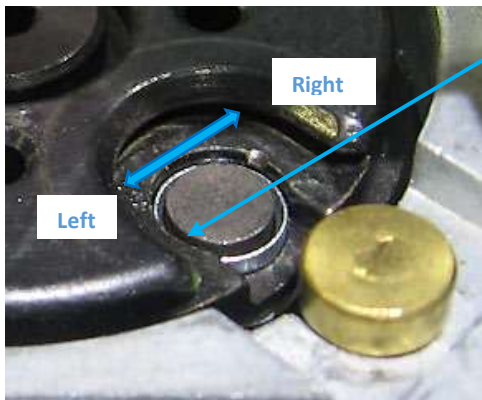

Primer Cup catching on left edge of Shellplate—under indexing—turn screw out $\frac{1}{4}$ turn

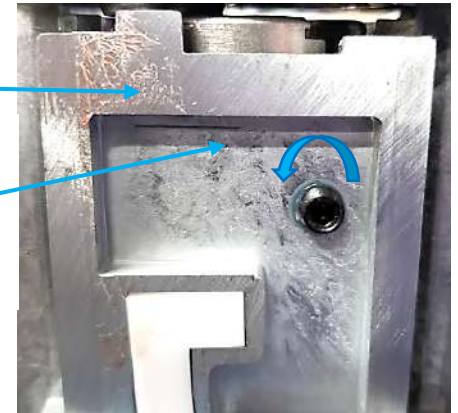

Index Limit Set screw—turn out to lengthen indexing—counter clockwise

10.2. Adjusting the Primer Drop Alignment in the Primer Feed Assembly

- Remove the 3 Mounting Screws and the Primer Feed Assembly from the Square Deal. Remove the Follower Rod and dump out any primers in the Primer Magazine Tube. Remove the Magazine Shield Cap and the Primer Magazine Tube. Remove the Magazine Tube. Compress the Primer Slide Assembly fully back against the Primer Slide Set Screw Stop with your finger while shining a small flashlight in the opening as shown below. Look down the Shield Tube and verify the Primer Hole in the Primer Slide is centered (concentric) under the opening in the Primer Feed body as shown below. If not, adjust the Primer Slide Stop Set Screw on the back of the Square Deal "B" in or out no more than $\frac{1}{8}$ of a turn at a time to fine-tune the position of the Primer Slide. See the graphical depiction below

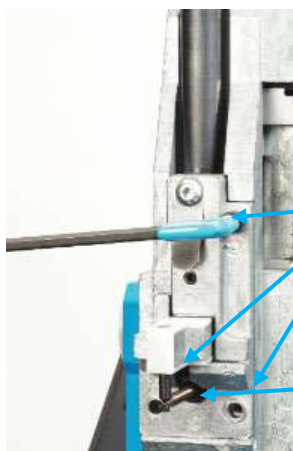

Remove the 3 Primer Slide Assembly Mounting Screws and the Primer Assembly

Primer Drop Cup Position Set Screw Stop



Remove Magazine Shield Cap and slide Magazine Tube up out of Magazine Shield





Push the Primer Slide Assembly firmly against the Set Screw Stop with your finger

WARNING! -Wear Safety Glasses

Shine a Flashlight here and look down Primer Shield Tube while adjusting the Set Screw in/out with an Allen Wrench to center the Cup in the Primer Feed Body Tube holding the all the way back with your finger



Correct View down inside Primer Shield Tube



End of Primer Cup Set Screw Stop

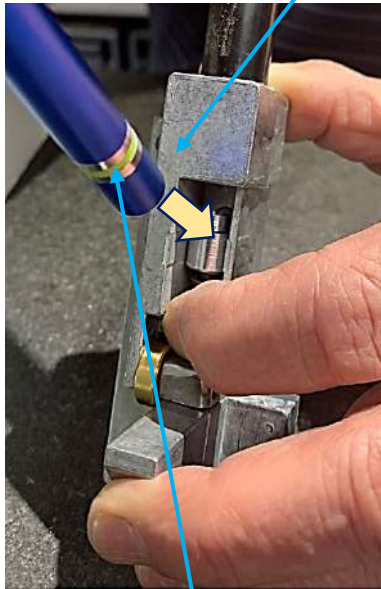

Flashlight



Primer Cup Set Screw Stop—adjustment side

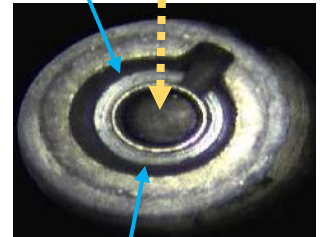

Primer Cup Centered in Primer Feed Body

- Reinstall the Primer Feed Assembly on the Square Deal with the Three Mounting Screws. Drop one primer in the Primer Magazine. Push the Operating Handle fully to the rear, the primer seating position. Verify the primer is now sitting on top of the Primer Punch as shown below. A small amount of over-travel to the rear for primer pickup is acceptable.

Drop one primer in Magazine

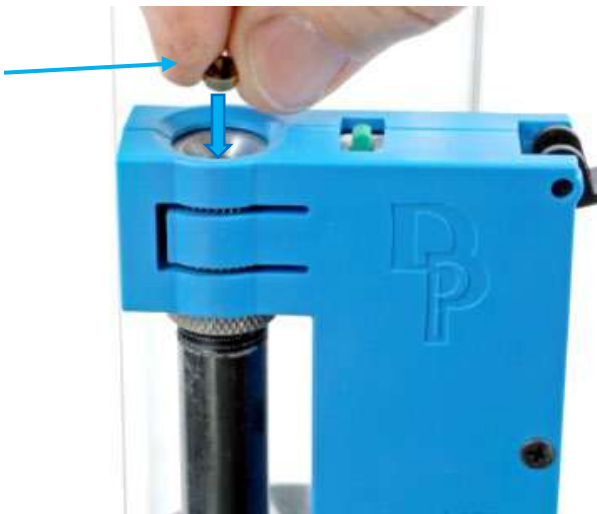

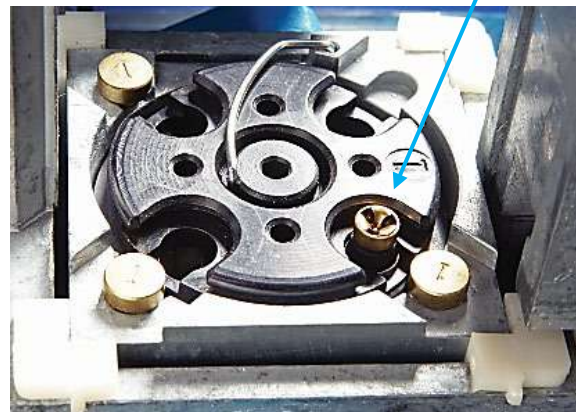

Proper primer presentation

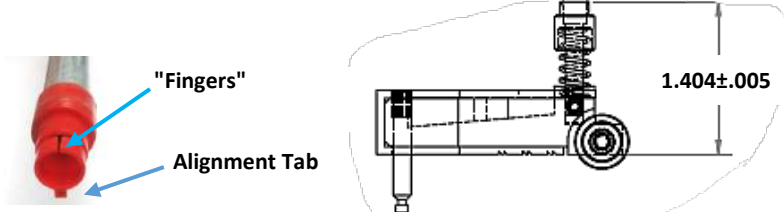
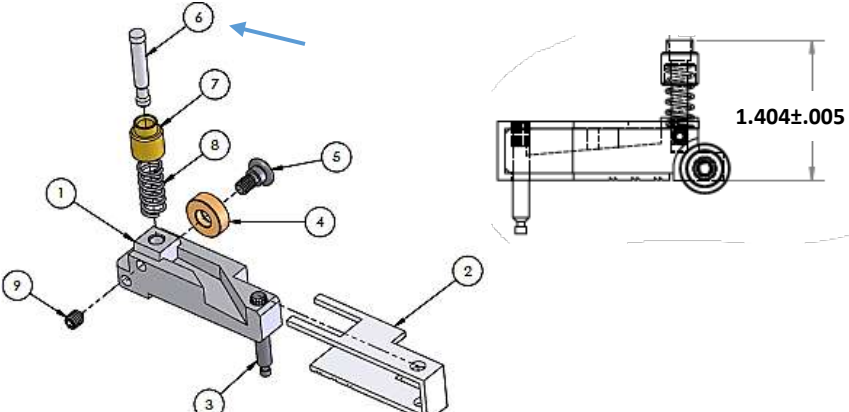
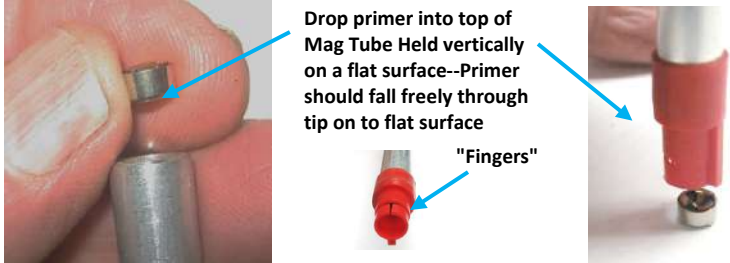

11. TROUBLESHOOTING GUIDE Square Deal "B"

No.	Category	Issue	Corrective Action
1	Cleanliness	The reloading process is inherently "dirty" because of residue from used primers, leftover corn cobb from tumbling and spilled powder. The general reloading process of sizing and seating bullets and primers can also generate metal particles. Live primer residue along with leftover Case Lube are other contaminants that need to be cleaned up.	<ol style="list-style-type: none"> 1. Compressed air or a "can of air" and a 1" paintbrush are the reloader's "best friends." At the end of a reloading session, blow out the Primer Slide and Shellplate areas. A small paintbrush can be used for cleaning spilled powder. 2. Periodically clean out the Size, Seat and Crimp Die with alcohol and swabs. They will get dirty over time.
		Brass residue can also build up on the end of Pistol Powder Funnels in the flaring process.	<ol style="list-style-type: none"> 1. Polishing the end of the Powder Funnel may also be necessary if the Funnel starts sticking inside pistol cases.
2	Indexing	Difficult Indexing	<ol style="list-style-type: none"> 1. Make sure the Shellplate Bolt is tight. 2. Wrong size Locator Buttons. 3. Sticky gunk or debris under the Shellplate. --Remove the Shellplate, clean with alcohol. 4. Make sure the Ejector wire is not dragging on the Shellplate. --Adjust Ejector Wire height to clear Shellplate.
		Shellplate over-traveling or "jumping backward" after indexing	<ol style="list-style-type: none"> 1. Index Ball and Spring stuck down with gunk or debris. --Remove Shellplate and clean bottom of Shellplate, Index Ball, Spring and Spring/Ball Pocket.
		Handle movement difficult	<ol style="list-style-type: none"> 1. Powder or other debris causing a jamming of moving parts. 2. Link Arm and/or Pins are worn or galled. --Clean and Relube. 3. Main Shaft or Wave Bearings are worn, sticky or dirty. --Clean and lubricate with 30 wt. oil. Do not use spray lubes like WD-40. 4. Priming System is not aligned with Platform/Shellplate. --Realign.
3	Depriming	Bending or breaking Depriming Pins	<ol style="list-style-type: none"> 1. Berdan case. 2. Smaller case inside the larger case. 3. Debris in cases.
4	Sizing	Scratched Cases	<ol style="list-style-type: none"> 1. Brass residue will build up in the Size Die (even carbide) over extended periods especially if the brass cases are not cleaned well. This very hard brass residue will leave vertical scratches on the case. Remove any hardened brass buildup in the size die with Red 3M Scotch Brite wrapped around a wood mandrel. Chuck the mandrel in a drill motor and run it gently back and forth inside the size die to remove hardened brass buildup. You can also use Sweets 7.62 Solvent. Remove all Sweets residue afterward. 2. Dirty Brass. 3. New Brass has burrs.
		Case stuck or sticking in Size Die	<ol style="list-style-type: none"> 1. Insufficient Lube on the case. 2. Overpressure or "blown-out" case—Case is out of spec/oversize. 3. Alcohol from Dillon Case Lube is not given time to evaporate.
5	Priming	Primers not feeding properly.	<ol style="list-style-type: none"> 1. Stuck Primer in the tube. Discard Tube. 2. Damaged Magazine Tip or Tube. Replace Tip or discard the Tube. 3. Debris preventing Primer Slide from traveling far enough into the Primer Feed body. --Remove and clean Slide and Feed body, or clear with compressed air. Primer Cup on Primer Slide not aligned properly with Magazine Tip.
		Primers may stick on the end of the Depriming Pin and be "pulled back up" into the primer pocket	<ol style="list-style-type: none"> 1. Polish the end tip of the Depriming Pin, so the taper is gone. This gives a wider tip, and the primer is less likely to get jammed onto it. Also, you can polish the end of the tip of the pin so it is less likely to get stuck in the primer anvil. 2. Make sure there are no "burrs" on the end of the Depriming Pin. Polish if necessary and make sure that the Spring-Loaded Depriming Assembly is intact especially the "E" clip on top of the Depriming Bolt Assembly.
		The Priming Cup is not picking up primers reliably under the Primer Magazine. Primers are being caught in Dispensing Tip	<ol style="list-style-type: none"> 1. Remove the Primer Magazine from the Magazine Shield. Caution! Any primers left in the Primer Magazine will fall out. Push a small cloth patch, 3/8" x 3/8", wet with alcohol, through the Magazine Tube several times to clean the interior. Verify the Dispensing Tip (Red or Blue) is not damaged--Replace if visibly damaged--see below. Verify that the Primer Slides is assembled properly and to the proper height as shown below:

			 <p>2.To replace the tip, remove the old tip and gently start the new tip on the aluminum Magazine tube. Make sure it is the correct size/color for the primers used—Blue for Small Primers and Red for Large Primers. Put the Magazine Tube in the Magazine Shield Tube and orient the tip in the mating slot inside the primer feed body. Screw magazine Cap on and gently use this to push the magazine tip on the rest of the way—do not over tighten.</p>
		Primer Slide is not moving smoothly back and forth	1.The Primer Roller or White Slide Bearing is dirty or worn. Disassemble and clean the Roller and both sides of the Primer Slide Bearing with Alcohol and reinstall using no lube! If worn call Dillon for a new Bearing.
		Primer Slide Punch, Cup and or Spring are Dirty or have come apart	<p>1.Disassemble Punch (6), Cup (7), and Spring (8) by loosening Set Screw (9), clean with alcohol, and dry.</p> <p>2.Re-assemble by fully compressing the Punch, Cup and Spring until they stop moving and firmly re-tightening the Set Screw (9)—Compressing the Spring requires some force—do not damage the top of the cup when doing this. The installed height should be as shown below—1.404±.005"</p> 
		Primer is not "Dropping" through the Magazine Tube	<p>1.Perform a single primer drop test with the Magazine Tube out of the system. Hold the Mag Tube vertically with the tip resting on a flat surface. Drop one primer into the top of the tube, shiny side down. Gently pick up the tube. The Primer should be sitting on the flat surface. If not, check the tip for damage and or burrs on the semicircular "fingers." If no damage and the primer is caught in the "fingers", gently and very lightly open the two "fingers." Try the test again. If still unsuccessful, replace the Tip and perform the test until successful.</p>  <p>Drop primer into top of Mag Tube Held vertically on a flat surface—Primer should fall freely through tip on to flat surface</p>
		Crushed primers	<ol style="list-style-type: none"> 1. Dirt or debris in Shellplate pockets. Remove with a pick or similar tool. 2. Crimped primer military brass. Military primer pockets must be chamfered or swaged before priming. 3. "Ringed" primer pocket. A remnant of the primer cup remains in the primer pocket after being de-primed. 4.Primer Punch is not assembled correctly in the Primer Slide. 5.Wrong size/type primer for that caliber. 6.Abrupt or jerky movement of the Operating Handle. Cycle the machine using a smooth motion. Slow down during the primer-seating step; be ready to stop if the primer is not seating smoothly or there is excessive seating resistance.

		A Primer is stuck in Pickup or Magazine Tube	1.Throw the tube away— Call Dillon for a new one at no charge! DANGER!!-Do not try to remove the primer!
		High Primers—Primers are not being seated flush or below flush with the bottom of the case.	1.Shellplate loose. Tighten the Shellplate bolt down until it is snug. 2.Insufficient force/rearward travel of the Operating Handle during the Primer seating cycle. 3.Primer Punch is not assembled properly in the Primer Slide. 4.Square Deal not fastened firmly to reloading bench.
		Unusual indentation in face of seated primer	2.There are powder granules on the top of the Primer Punch Face imprinting into the Primer—clean off/blow out spilled powder granules.  Crushed powder granule imprinted into primer
		Used primers backed up in Shellplate—not dropping into Used Primer Cup on the bottom of the Square Deal	1.The used primer track collects burned powder and primer residue—remove the Track Cover and clean the track under the plastic track cover on the right side of the Shaft.  White Plastic Primer Track Cover removed Primer Track
6	Case Flaring -Belling	Erratic flaring (too much or too little).	1.Variation in case length. Measure cases, trim or discard cases out of spec. 2.Handle not moving all the way down on each cycle. 3. Wrong Powder Funnel for that caliber. 4. Improper Powder Die adjustment. 5.Powder Measure loose on Powder Die.
7	Powder Funnel sticking in case	Brass residue can build up on the end of Pistol Powder Funnels in the flaring process.	1.Polish the end removing any brass buildup and lightly lube with Case Lube.
8	Powder Measure	Inconsistent Powder Charges	1.Be sure that the Failsafe Return Rod Blue Wing Nut is tight enough to fully retract the Powder Bar. With the handle fully down, tighten the Blue Wing Nut until two business cards just slip between the coils of the spring. Adjust Powder Die height to obtain full Powder Bar travel. 2.Powder not settled in Hopper. --Cycle more powder charges until stable. 3.Wrong size Powder Bar for requirements. --Replace Powder Bar. 4.Powder Measure loose on Powder Die. --Tighten Clamping Screws. 5.Slow down cycling, 6.Small Powder Bar Spacer Plug missing. —Replace it.
		Powder bar not moving smoothly	1.Dirty or gummy--Clean with isopropyl alcohol or acetone. Do not lubricate. Do not use sandpaper, file or anything abrasive. 2.Powder bar, Small Bar Spacer or Powder Measure Body galled or worn. Return to Dillon for repair or replacement. 3.Failsafe Rod Assembly missing or disconnected. 4. Very fine-grained spherical powder like Win 296, H110 and some Accurate Arms powder can get between the Powder Bar, Spacer and/or the Powder Measure Body and bind movement. 5.Powder Bar Adjustment Bolt adjusted fully open against the stop. This can bind the Powder Bar insert causing the Powder Bar to drag.
10	Bullet Seating	The case neck is crumpling when the bullet is seated	1.On straight wall and tapered cases, flare the case mouth to at least .010" larger, and up to .020" larger than a sized, unflared case.
		Bullet falling through case mouth or cartridge neck	1. The case was not sized. 2. The bullet diameter is incorrect. -- Check bullet.
11	Bullet Crimping	The case is bulged and the case will not fit in the Case Gauge	1. Raise the Crimp Die reducing the amount of crimp.

12. CLEANING AND LUBRICATING THE SQUARE DEAL "B"--Operating circumstances will dictate the frequency of required lubrication. Clean and lube the Square Deal every 10,000 cycles of operation. Use a high-grade, conventional wheel bearing grease--do not use oil except as indicated below. The lubricants to be used are chassis lube such as Schaeffer High-Performance Grease NLGI#229 High Moly Content (or equivalent) and Supreme 7000 Synthetic Plus 30W Motor Oil or equivalent.

12.1. Dillon offers a Square Deal "B" Series Machine Maintenance Kit (PN22211) that helps maintain the Square Deal "B":

- Square Deal Spare Parts Kit--PN90715
- Compressed Air
- Pipe Cleaners
- Lubricating Grease Syringe
- Nylon Brush



12.2. Remove, Clean and Lubricate the Link arm bearings on each side of the press, the 4 Corner Wave Bearings, the Mainshaft Pivot Pin and the Used Primer Track every 10,000 cycles.

- Remove the 4 BHCS (13896) that retain the Link Arms (13822) to the Frame and Operating Handle and the Link Arms. The Mainshaft with the Handle attached will slide down out the bottom of the Frame.
- Clean and lightly Oil four corner edges of the Mainshaft and associated Plastic Wave Bearings with 30W Oil. Wipe off any excess.



Use only 30 weight motor oil on all four corners

DO NOT use a penetrating lubricant such as WD-40, BreakFree, etc.

- Loosen the Pivot Pin retaining Set Screw in the Operating Handle (13718) with an Allen Wrench, slide the Pivot Pin (13622) out of the Mainshaft. Clean, apply grease and reinstall.

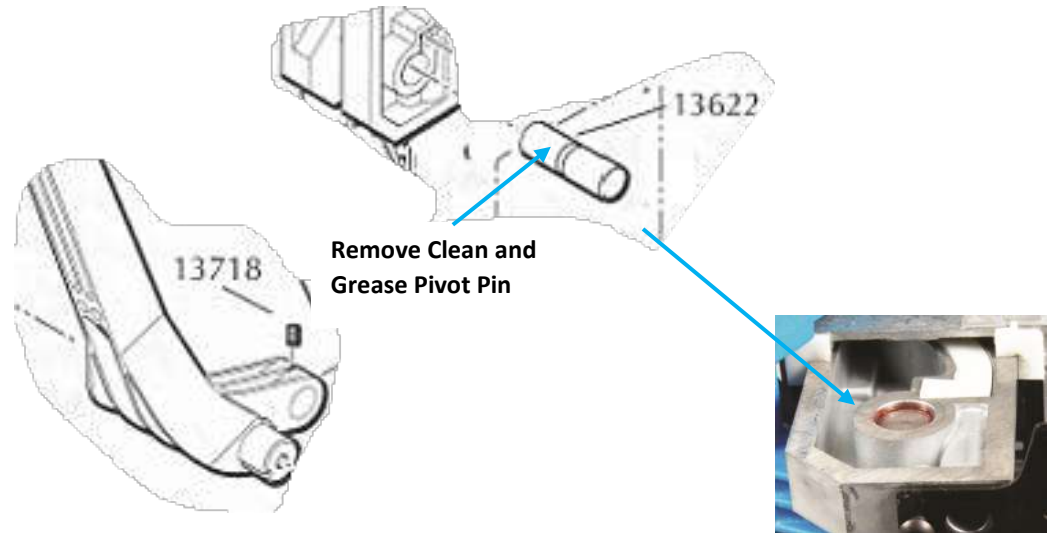

- With the Mainshaft out of the Frame, carefully pry the white plastic spent Primer Track Cover from the right side of the Square Deal Mainshaft and clean the primer and powder residue out of the Track. Reinstall the Track Cover.

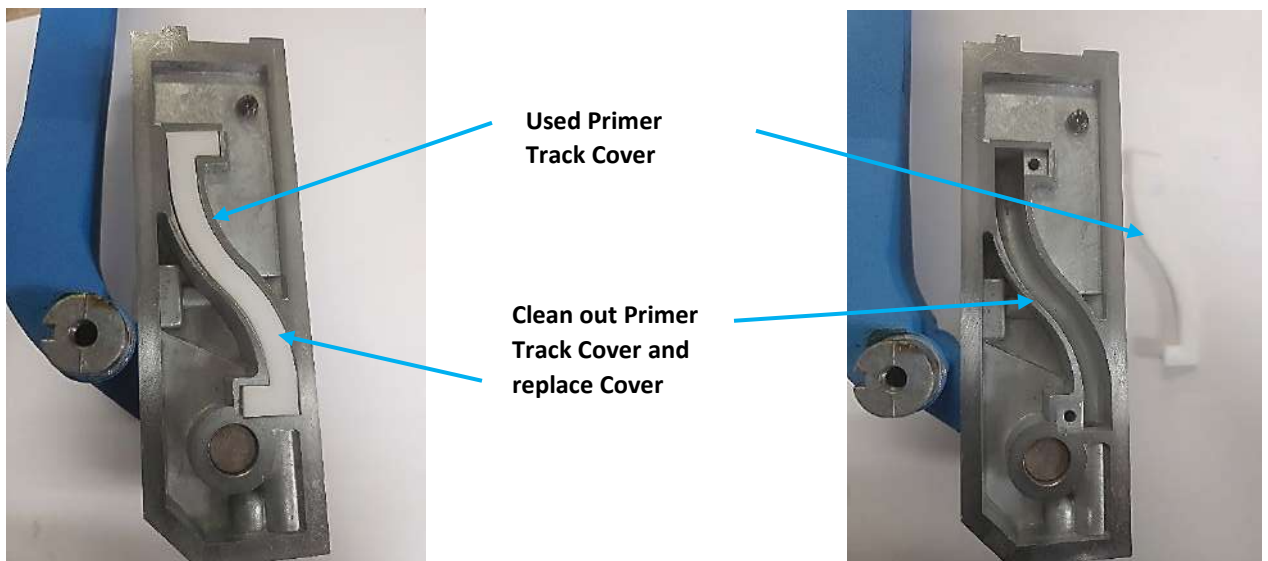

- Clean and lightly grease each one of the 4 Brass Bearings (18077).
- Reinstall the Mainshaft in the Frame and reinstall the four Link Arms Brass Bearings, the two Link Arms in the correct orientation (Dillon to the outside and right side up), Washers and re-tighten the Retaining Screws

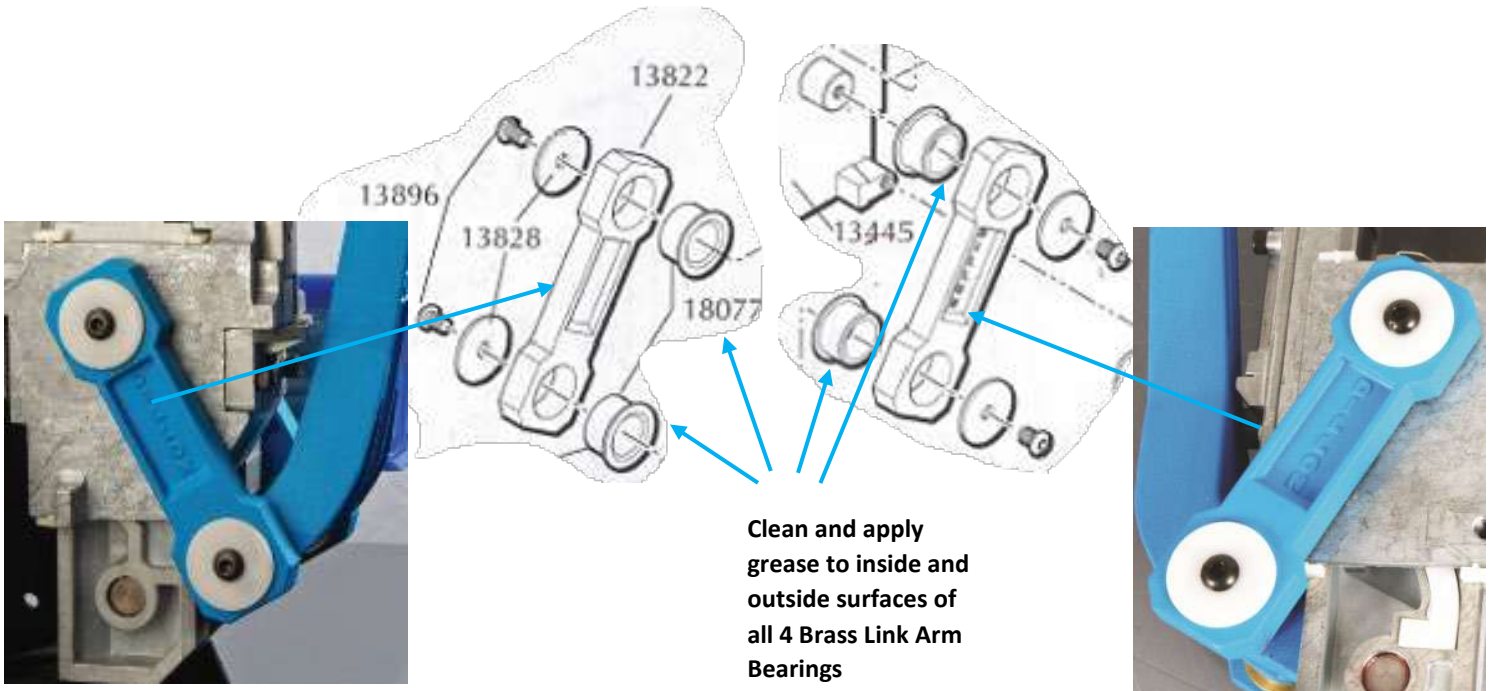

12.3. General Cleanliness

- The reloading process is inherently "dirty" because of residue from used primers, leftover corn cobb from tumbling and spilled powder. The reloading process of sizing, seating bullets and primers can generate metal particles. Carefully blow the system out frequently and remove any debris.

13. DILLON PRECISION Square Deal "B" EXPLODED VIEWS AND PARTS IDENTIFIER

13.1. Main Assembly

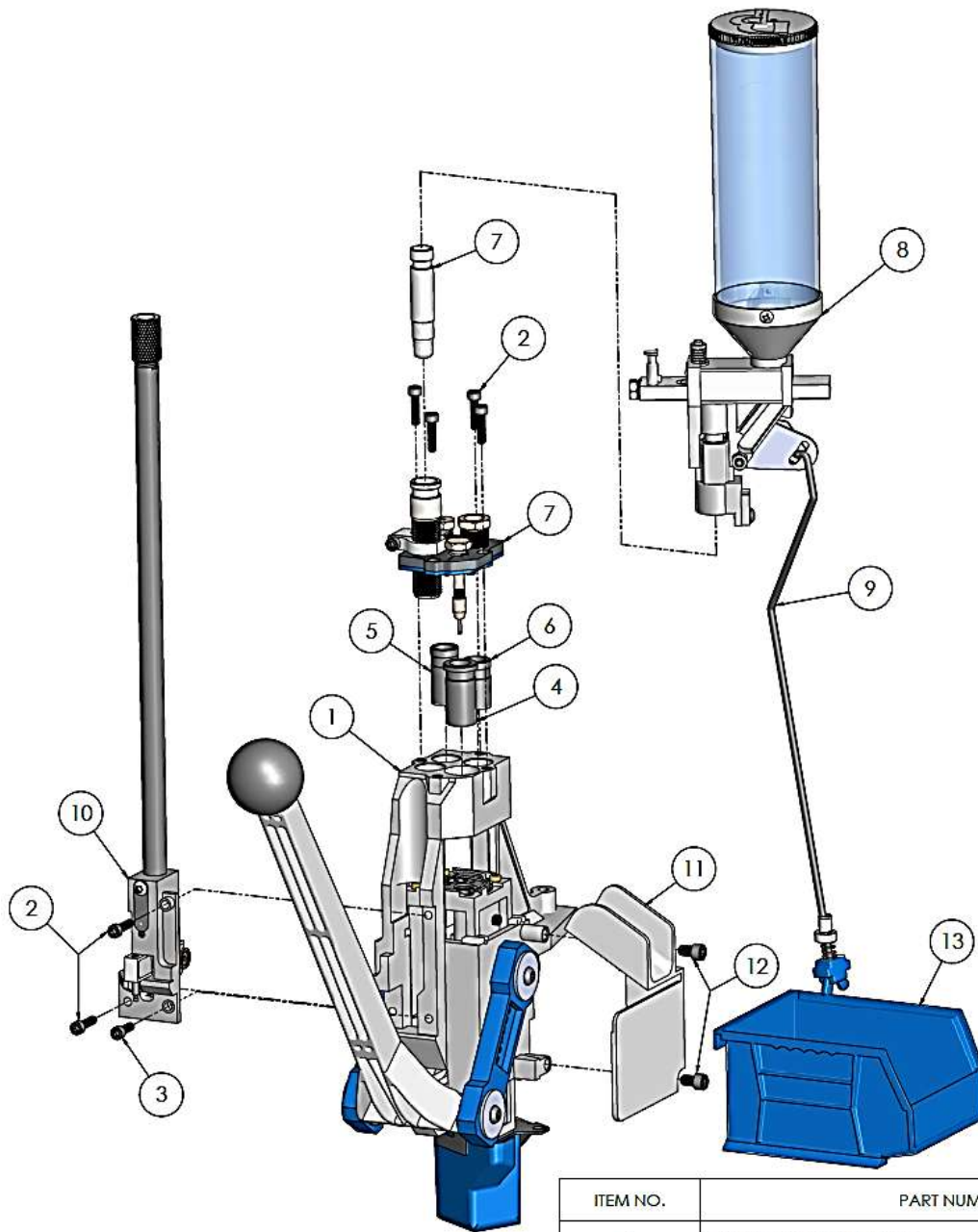

ITEM NO.	PART NUMBER	QTY.
1	FRAME AND LOWER ASSEM	1
2	14037_10-24x750 SHCS	6
3	13989_10-24x625 SHCS	1
4	22204_45 SIZER ASSEM*	1
5	11628_45 ACP SD SEAT INSERT*	1
6	11734_45 ACP-GAP SD CRIMP INSERT*	1
7	SD TOOLHEAD ASSEM 45 WITH POWDER FUNNEL*	1
8	22220_POWDER MEASURE SD	1
9	16814_SD FAILSAFE ROD ASM	1
10	20253_SD PRIMER FEED LARGE*	1
11	13659_SD CHUTE BRACKET	1
12	13976_250-20x375 SHCS	2
13	13756_BULLET BIN	1

* = CALIBER SPECIFIC

13.2. Frame and Lower Assembly

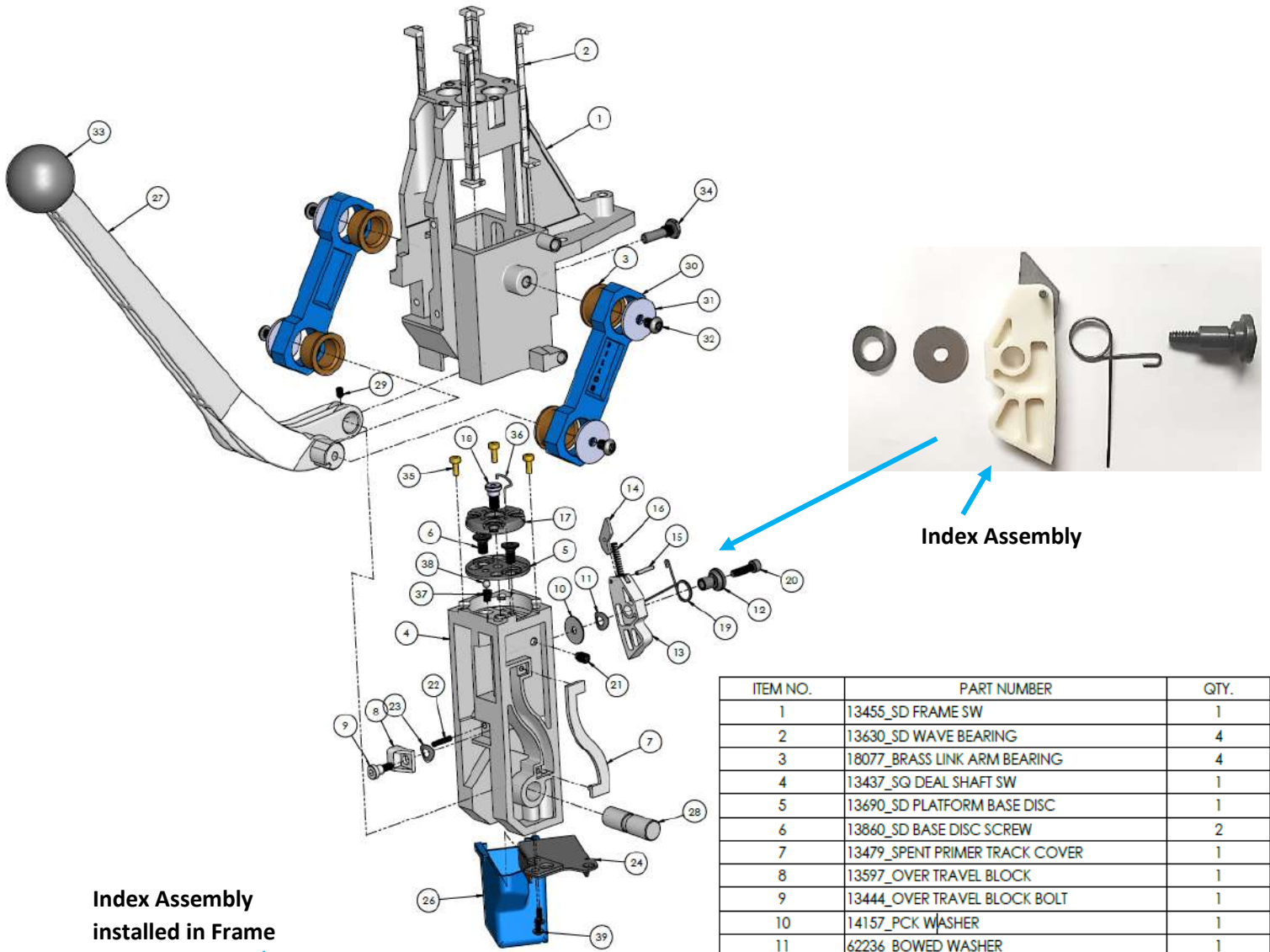

Index Assembly installed in Frame

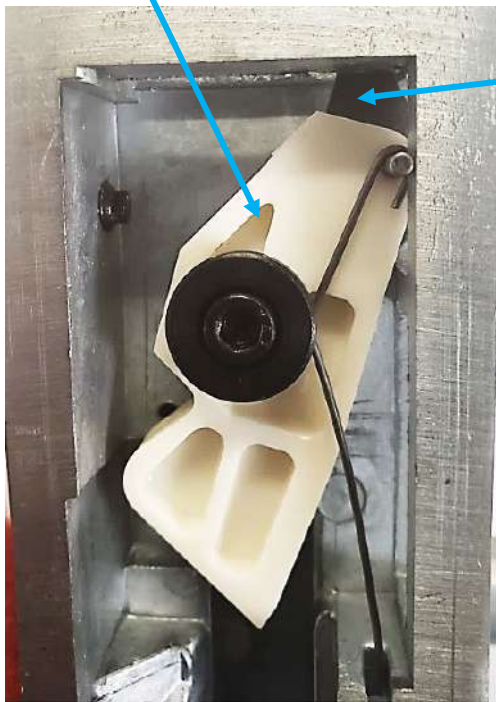

Index Pawl ⑭

ITEM NO.	PART NUMBER	QTY.
1	13455_SD FRAME SW	1
2	13630_SD WAVE BEARING	4
3	18077_BRASS LINK ARM BEARING	4
4	13437_SQ DEAL SHAFT SW	1
5	13690_SD PLATFORM BASE DISC	1
6	13860_SD BASE DISC SCREW	2
7	13479_SPENT PRIMER TRACK COVER	1
8	13597_OVER TRAVEL BLOCK	1
9	13444_OVER TRAVEL BLOCK BOLT	1
10	14157_PCK WASHER	1
11	62236_BOWED WASHER	1
12	13797_SD INDEXER PIVOT BUSHING	1
13	13714_INDEX LEVER PRODUCTION	1
14	13705_SD INDEX PAWL REV. 2	1
15	13776_PAWL PIN	1
16	13624_PAWL SPRING RL1000	1
17	13653_SHELLPLATE 1*	1
18	13328_SD SHELLPLATE BOLT	1
19	13944_INDEX LEVER SPRING	1
20	14014_10-24x875 SHCS	1
21	13789_250-28x375 DOG PT SET	1
22	13847_SD OVERTRAVEL SPRING	1
23	14041_250 BOWED WASHER	1
24	17212_SD SPENT PRIMER CUP BRACKET	1
26	16211_SPENT PRIMER CUP	1
27	13641_SD HANDLE LEVER	1
28	13622_SD CRANK PIN	1
29	13718_8-32X250 SET SCREW	1
30	13822_SD LINK ARM	2
31	13828_LINK ARM WASHER	4
32	13896_250-20 BHCS	4
33	13850_HANDLE BALL	1
34	13461_SQUARE DEAL INDEXING BOLT	1
35	LOCATOR BUTTON #1 *	3
36	13433_SD EJECTOR WIRE	1
37	13739_SD DETENT SPRING	1
38	14019_188 DETENT BALL	1
39	13719_8-32x375 BHCS	2

* = CALIBER SPECIFIC

13.3. Typical Toolhead Assembly (45ACP Shown)

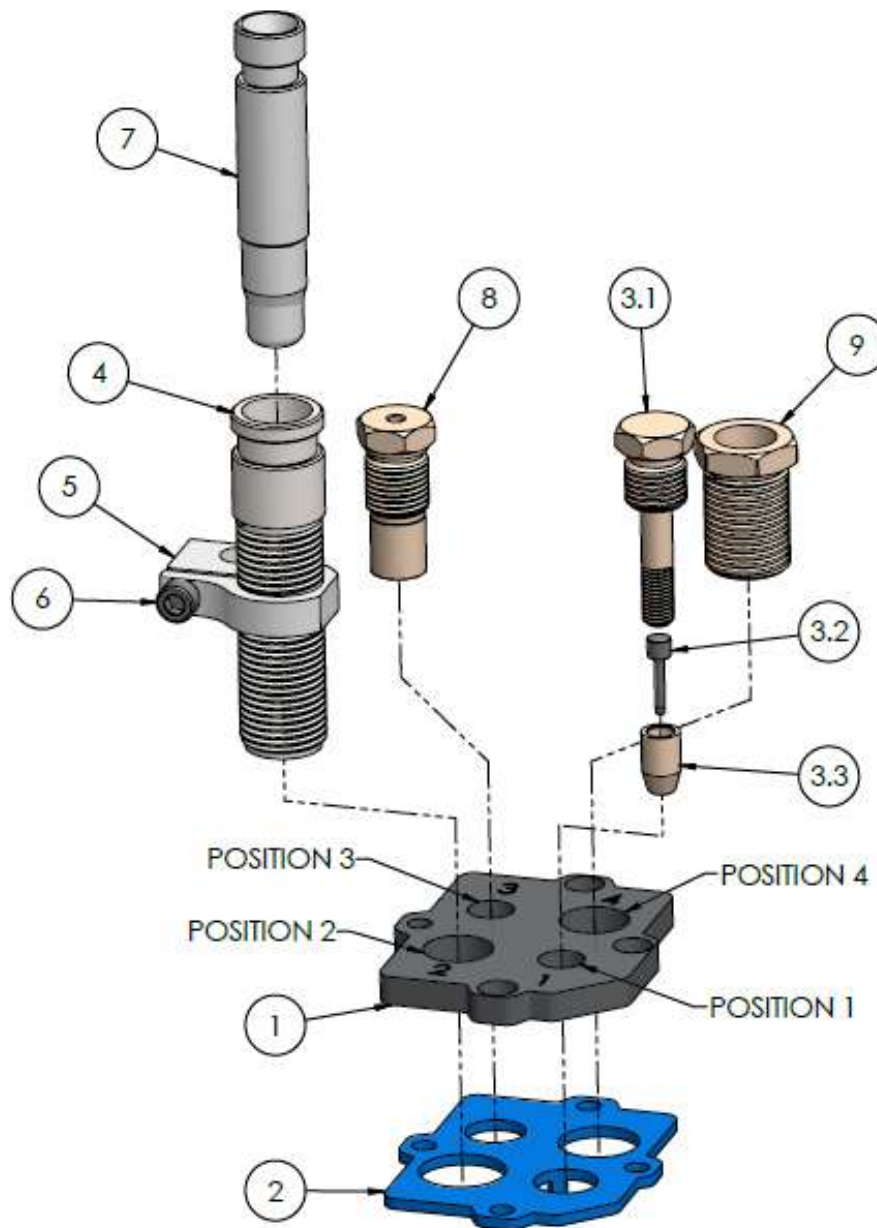

ITEM NO.	PART NUMBER	QTY.
1	13712_SQUARE DEAL TOOLHEAD PLATE	1
2	13721_SQUARE DEAL TOOLHEAD FRICTION PLATE	1
3	POSITION 1, SIZE AND DECAP: 22200_SD DECAP ASSEM	1
3.1	13843_SD DECAP SCREW	1
3.2	13753_PISTOL DECAP PIN VER2	1
3.3	13429_DECAP NUT	1
4	POSITION 2, POWDER: 13865_SQ DEAL POWDER DIE	1
5	13764_SD POWDER DIE LOCK RING	1
6	14037_10-24x750 SHCS	1
7	13782_POWDER FUNNEL E*	1
8	POSITION 3, BULLET SEATING: 12476_45 RN SEAT STEM*	1
9	POSITION 4, CRIMPING: 19838_SD NEW CRIMP ADJUSTMENT SCREW	1

* = CALIBER SPECIFIC

13.4. Automatic Primer Assembly

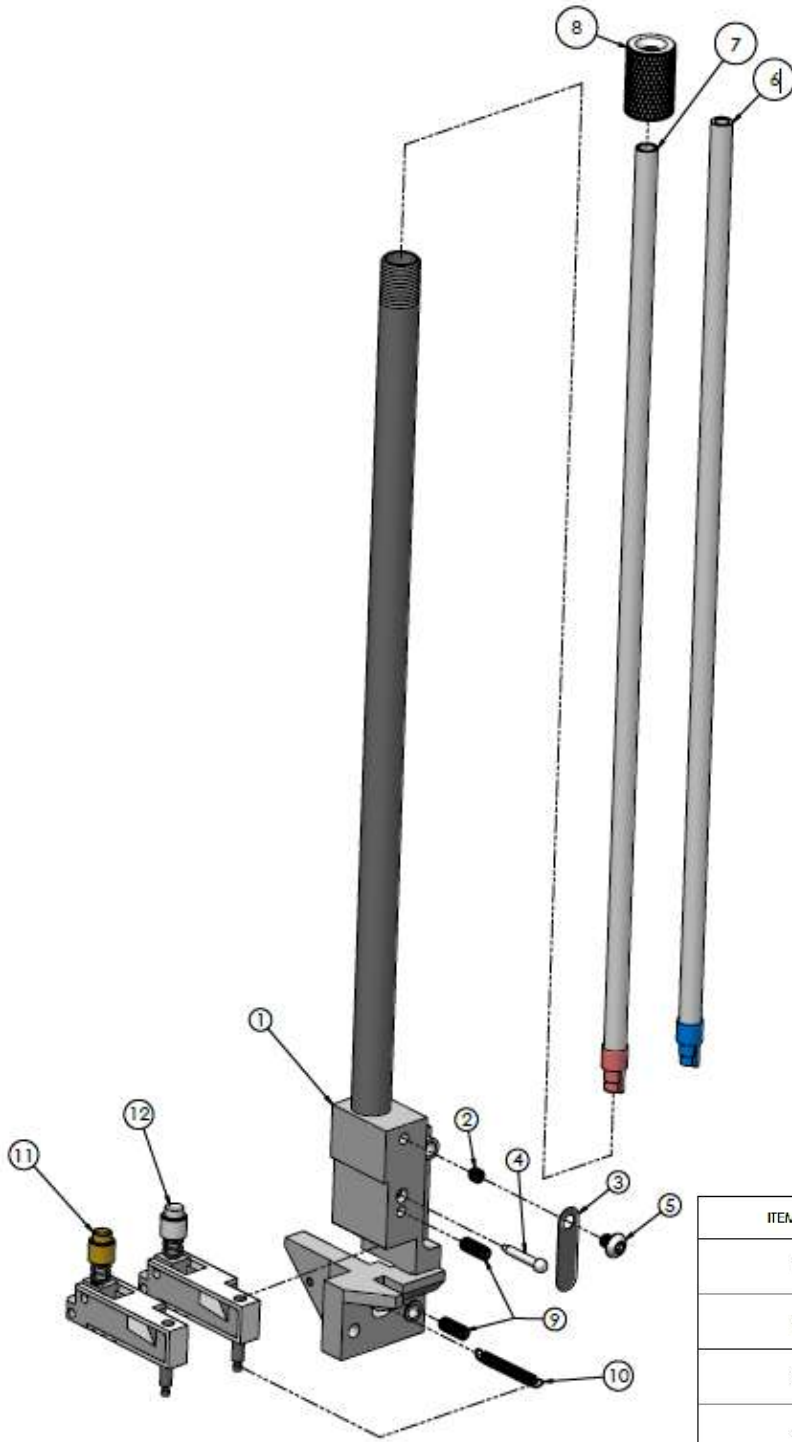

ITEM NO.	PART NUMBER	QTY.
1	20900_SD PRIMER BODY WITH SHIELD	1
2	13796_10-24X168 KNURL PT SET	1
3	13979_560 PRIMER FEED STOP SPRING	1
4	14051_PRIMER FEED STOP PIN	1
5	13964_10-24x250 BHCS ZINC	1
6	13079_SMALL MAG TUBE ASSEM	1
7	22031_LARGE MAG TUBE ASSEMBLY	1
8	13957_PRIMER SHIELD CAP	1
9	13961_10-24x500 SET SCREW	2
10	13796_SD PRIMER SLIDE RETURN SPRING	1
11	20125_SD PRIMER SLIDE SMALL	1
12	20124_SD PRIMER SLIDE LARGE	1

13.5. Primer Slide Assemblies—Large Primers--20124 Small Primers--20125

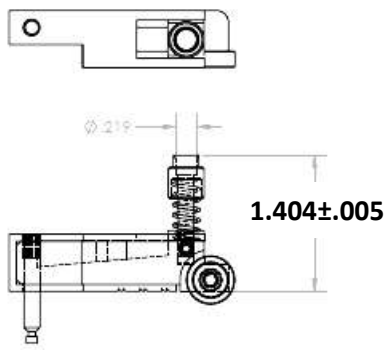

20124, SQ DEAL PRIMER SLIDE LARGE ASSEM

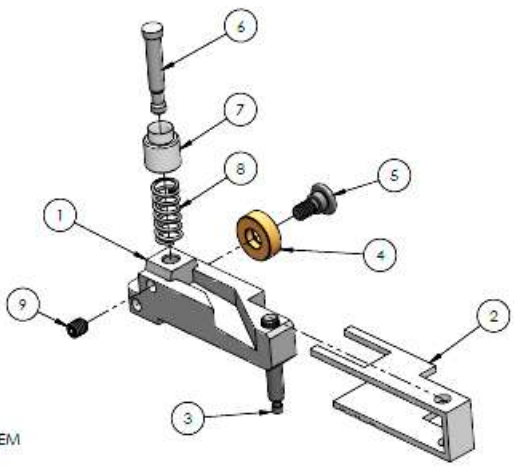

ITEM NO.	PART NUMBER	QTY.
1	13754_SD PRIMER SLIDE	1
2	13722_PRIMER SLIDE SHIM	1
3	13790_PRIMER SLIDE RETURN SPRING PIN HEADED	1
4	13689_SD PRIMER SLIDE ROLLER	1
5	13809_SD ROLLER BOLT	1
6	13967_550 LARGE PRIMER PUNCH	1
7	13621_SD LARGE PRIMER CUP	1
8	13982_SD SEATING PUNCH SPRING	1
9	13823_8-32X188 SET SCREW	1

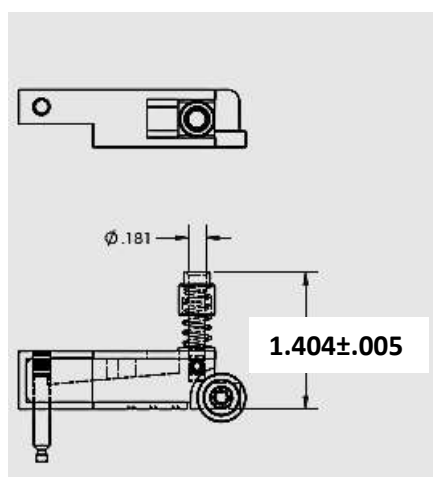

20125, SQ DEAL PRIMER SLIDE SMALL ASSEM

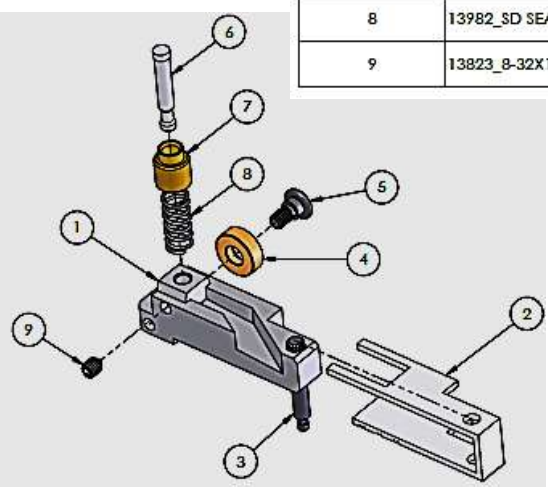

Small Primer Slide
Large Primer Slide

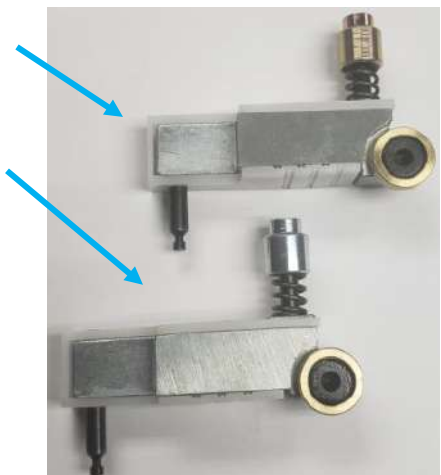

ITEM NO.	PART NUMBER	QTY.
1	13754_SD PRIMER SLIDE	1
2	13722_PRIMER SLIDE SHIM	1
3	13790_PRIMER SLIDE RETURN SPRING PIN HEADED	1
4	13689_SD PRIMER SLIDE ROLLER	1
5	13809_SD ROLLER BOLT	1
6	13757_550 SMALL PRIMER PUNCH	1
7	13657_PRIMER CUP SMALL	1
8	13982_SD SEATING PUNCH SPRING	1
9	13823_8-32X188 SET SCREW	1

13.6. Primer Early Warning System

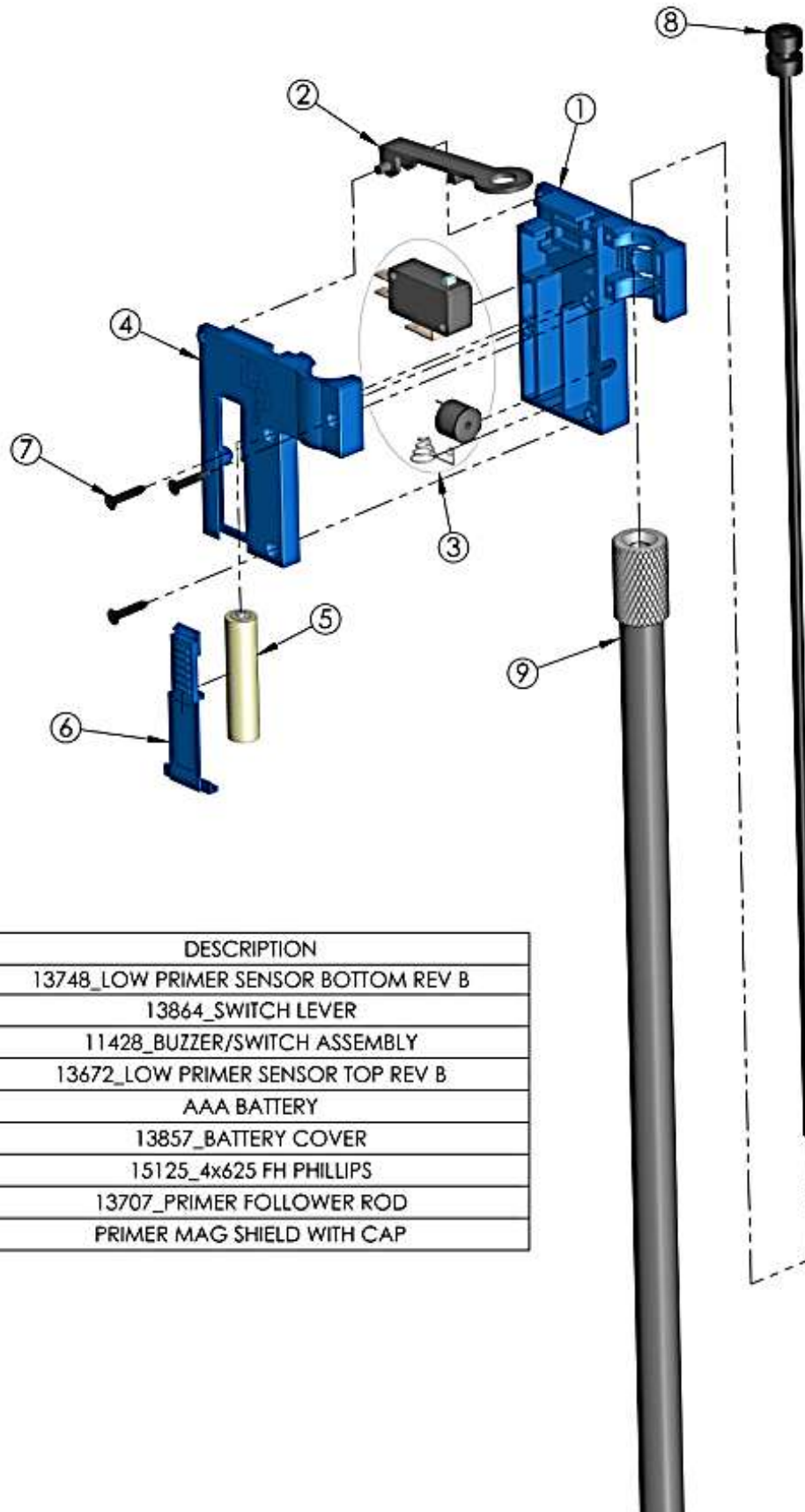

NUMBER	DESCRIPTION
1	13748_LOW PRIMER SENSOR BOTTOM REV B
2	13864_SWITCH LEVER
3	11428_BUZZER/SWITCH ASSEMBLY
4	13672_LOW PRIMER SENSOR TOP REV B
5	AAA BATTERY
6	13857_BATTERY COVER
7	15125_4x625 FH PHILLIPS
8	13707_PRIMER FOLLOWER ROD
9	PRIMER MAG SHIELD WITH CAP

14. RELOADING BASICS

14.1. Clean Brass Is Required Before Reloading

- There are many methods for cleaning fired brass, but the tried and true method is tumbling brass in a Dillon Vibratory Tumbler with ground corncob or walnut shell media with 2-3 “caps-full” of Dillon Case Polish. Putting a “clothes dryer sheet” in with the media helps control dust.



Dillon PN13804



Dillon PN20439

14.2. Lubricating Brass

- Pistol Brass—pistol brass should be lightly lubricated before sizing even if you are using a carbide size die. The most effective lubricant for cases is lanolin/isopropyl alcohol-based, as in the Dillon Case Lube PN13733.
- Lubricate your clean cases by laying the brass flat on their sides in a shallow box or “cookie tray.” Pump three or four sprays on the cases and shake the box so the cases tumble and roll. Repeat this process one more time making sure that the lubricant is distributed over the cases. Let the cases dry for about 3-4 minutes before using them.



Dillon PN13733



14.3. Head Space—Case Sizing

- Headspace is an important reloading parameter. Cartridge headspace is the distance from the case head to the part of the case on which the cartridge stops moving forward in the chamber. Chamber headspace is the distance from the breech face to the part of the chamber that stops the case from moving forward. Headspace in its common usage (head clearance) is the difference between the chamber headspace length and the cartridge headspace length or the amount of clearance front to back the cartridge has in the chamber. If the cartridge headspace length is too long for the chamber, action will not close and the firearm will not go into battery. If the cartridge headspace length is too short for the chamber (too much front-to-back clearance), the primer may not go off, you may get poor accuracy, stretched brass, short brass life, flattened primers or case head separation.

- Cartridge types head space differently. Rimless auto pistol cases headspace on the mouth of the case. Rimmed cases headspace on the rim.

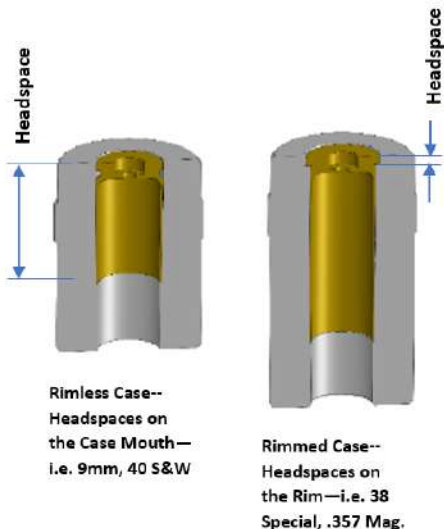

- When a straight wall cartridge is fired, the case expands in diameter to take up all the available space in the chamber and seals in the propellant gases. After being fired the cartridge case “springs back” so the case can be extracted from the chamber. The case does not return to its original unfired dimensions. Therefore, the case must be sized. Sizing of the straight-walled rimmed or rimless case “squeezes” the case back to its original diameter so that it will fit in any firearm and hold a bullet. A bullet will fall through the mouth/neck of an un-sized case.

14.4. Documentation

- It is important to keep records of the important parameters that were used in reloading the cartridge in a record book and labeling the cartridge storage container. A quantity of 100” stick-on” labels with loading parameters is available from Dillon PN10446—see below. Recording additional data such as the Date and the Powder Lot number is also recommended.

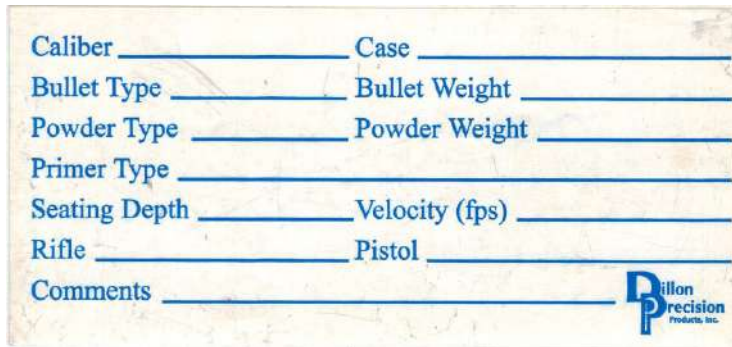

Reloading Stick-On Label PN10446

15. PRIMER BASICS

- ***DANGER! Primers contain a small amount of a shock-sensitive chemical that explodes when struck by a firing pin or hammer which then sets off the powder/propellant and provides an initial pressure to assist the propellant to reach a self-sustaining burn. It is also part of the propellant gas sealing system. Primer elements are shown below. Primers must be installed/seated to a recommended .002” to .006” (.008” Max.) below flush so that the Anvil contacts the bottom of the primer pocket to provide reliable ignition.***

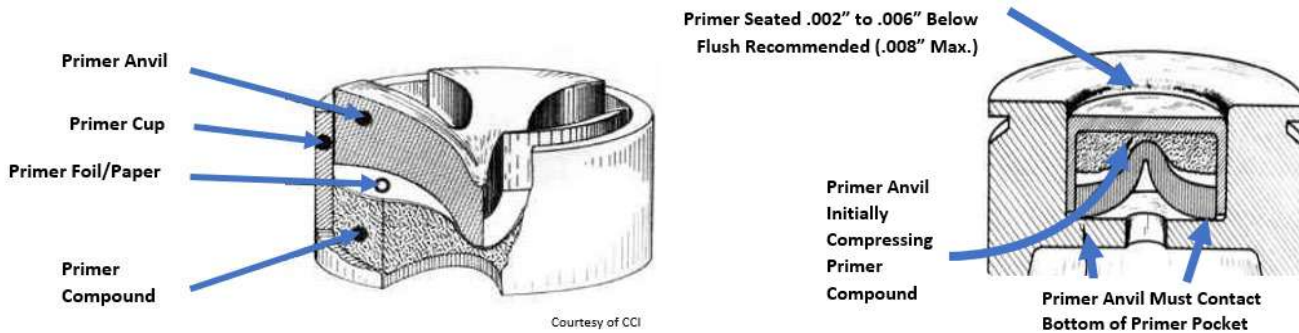

- **DANGER!** Primers can also detonate if accidentally crushed. Never force primers or subject them to excessive heat. If primers become stuck in the operation of the reloader, carefully disassemble the reloader and gently remove the obstruction. Never attempt to clear primers that are stuck in either the primer pickup tube or the primer magazine tube. Never, under any circumstance, insert any type of Rod into these tubes to push out stuck primers—PRIMERS CAN “CHAIN DETONATE.” If a primer(s) is stuck in the magazine or pickup tubes flood the tube with penetrating oil/WD40, throw it away and call Dillon for a free replacement. Never attempt to deprime a cartridge case with a live primer. Depriming a live primer is dangerous and can cause serious injury or death.
- **CAUTION!**--Primers can leave a residue of primer “dust” behind especially if using a vibratory auto primer loader. An accumulation of dust is a fire and an explosion hazard. Keep the loading area and equipment free of any accumulated primer “dust.” Use alcohol and paper towels to remove this residue.
- **WARNING!**--Using the right primer is a very important issue in the reloading process. Use the primer recommended in your reloading manual for that specific load.
- There are two basic types of cartridge cases and associated primers--Boxer and Berdan. The Boxer brass cartridge case and Boxer primers are what is reloadable and discussed here. **WARNING!** --Do not use Berdan cases. Berdan cases will destroy the depriming pin. Boxer primers will not seat properly in a Berdan primer pocket.



- There are two sizes of Pistol primers for Boxer Centerfire Cartridges:
 - Small Pistol
 - Large Pistol
 - There are also magnum pistol primer varieties
 - **WARNING!**--Reloading manuals specifically define the primer used for the cartridge and the bullet being reloaded! Primers can dramatically affect the pressure, velocity and accuracy of the reloaded cartridge.
 - SAAMI Standard Dimensions for Primers:

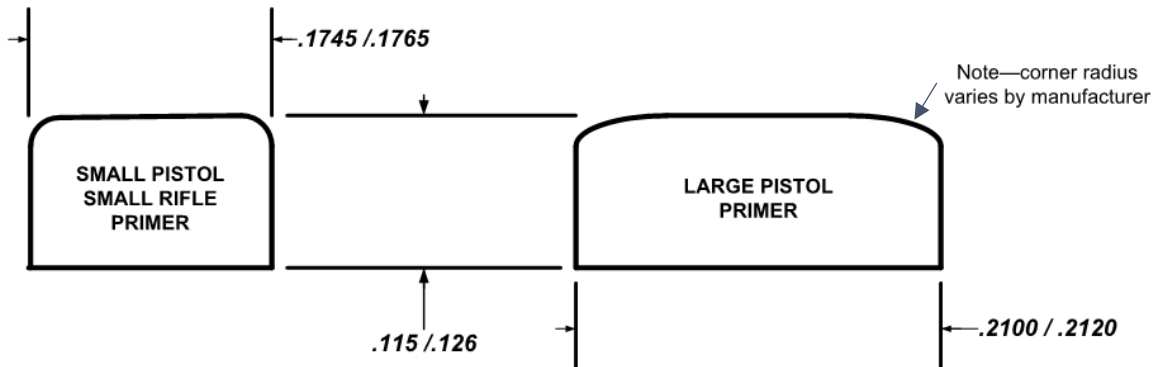

Dillon Precision Inc.
8009 E. Dillon's Way
Scottsdale, AZ 85260
480-948-8009 1-800-223-4570
FAX 480-998-2786
Website: www.dillonprecision.com
E-mail: dillon@dillonprecision.com